



Friends™

41733





Get excited about our new packaging!

We're switching from plastic to paper-based packaging. That's why you might find a mix of paper and plastic in our boxes!

Nos nouveaux emballages vous emballeront !

Nous passons des emballages en plastique aux emballages à base de papier. C'est pourquoi vous pourriez trouver un mélange de papier et de plastique dans nos boîtes !

¡Te presentamos nuestros nuevos empaques!

Estamos sustituyendo las bolsas de plástico por bolsas con base de papel. ¡Por eso, puedes encontrar una mezcla de papel y de plástico en nuestras cajas!

[LEGO.com/sustainable-packaging](https://www.lego.com/sustainable-packaging)



BUILDER



Apple and the Apple logo are trademarks of Apple Inc., registered in the U.S. and other countries and regions. App Store is a service mark of Apple Inc. Google Play and the Google Play logo are trademarks of Google LLC. Tencent and the Tencent logo are trademarks of Tencent Inc.

Q [LEGO.com/devicecheck](https://www.lego.com/devicecheck)

EN Ask parents' permission before going online | **DE** Eltern um Erlaubnis bitten, bevor du online gehst | **FR** Demande l'autorisation d'un parent avant d'aller en ligne | **IT** Chiedi il permesso ai tuoi genitori prima di andare online | **ES** Pídeles permiso a tus papás antes de conectarte a Internet | **PT** pede autorização aos pais antes de acederes online | **JA** オンラインになる前に ほんごの かのきょかをもらおう | **ZH** 上网前应先征得父母的同意 | **KO** 온라인 접속 전에 보호자 동의가 필요합니다 | **RU** Спроси разрешения у родителей, прежде чем заходить в интернет | **PL** Poproś rodziców o zgodę, zanim wejdiesz do Internetu | **CS** Než půjdeš na internet, požádej rodiče o svolení | **SK** Skôr než pôjdeš na internet, vypýtaj si povolenie od rodičov | **HU** Kérj szülői engedélyt, mielőtt online csatlakoznál! | **RO** Cere permisiunea părinților înainte de a te conecta online | **BG** Поискайте разрешение от родител, преди да влезете онлайн | **LV** Pirms došanās tiešsaistē palūdz atļauju vecākiem | **ET** Enne Interneti kasutamist küsi vanematelt luba | **LT** Prieš prisijungdami prie interneto, atsiklauskite tėvų



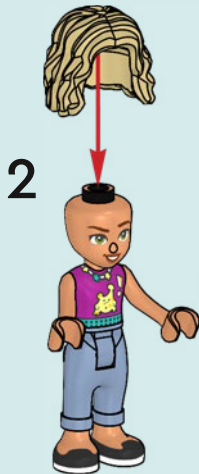
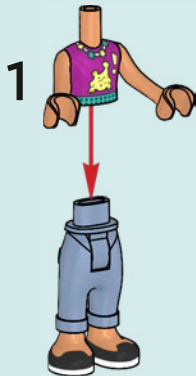

NOVA





1x



1x

1



2



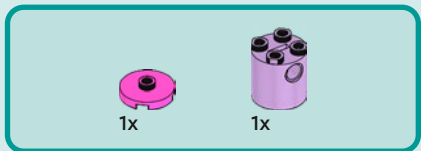

1

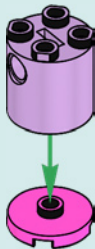



2x

2

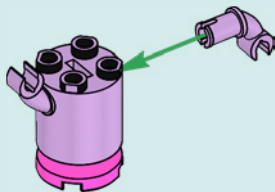

3



4

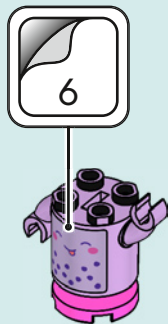



1x



1x

5





1x

6



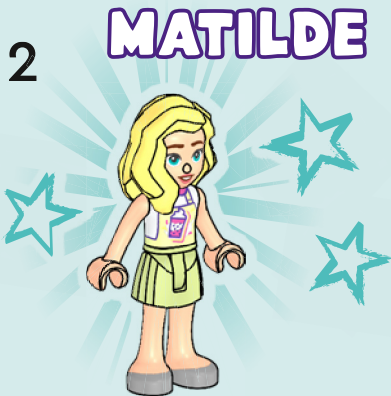
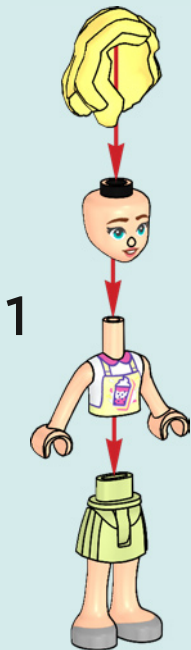

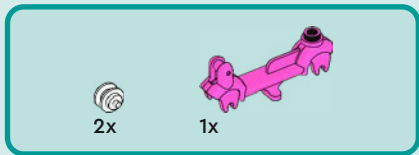
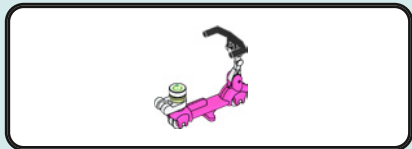

1

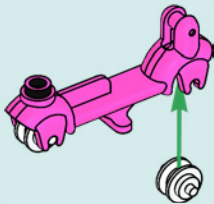



1x



1x

2

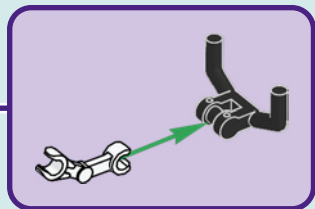
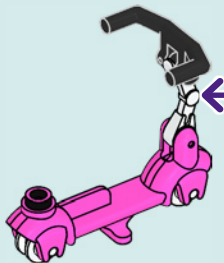



1x



1x



1x

3

1



2

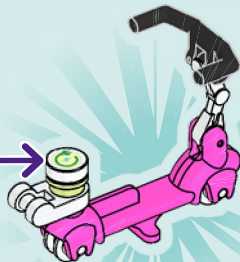

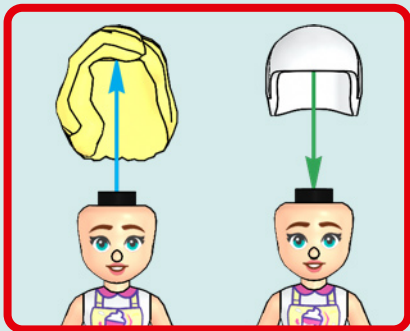

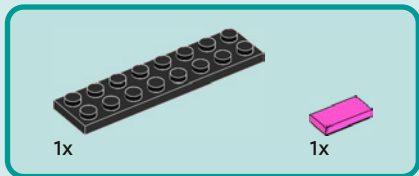
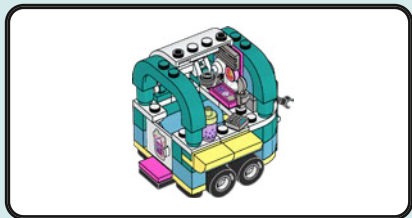

1

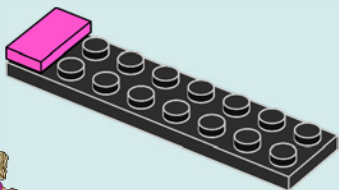

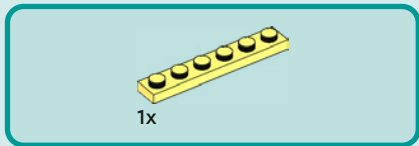

2

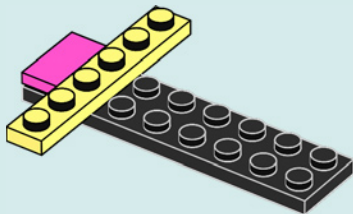



2x

3

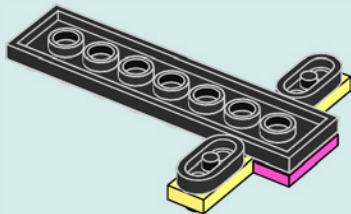



4x

4

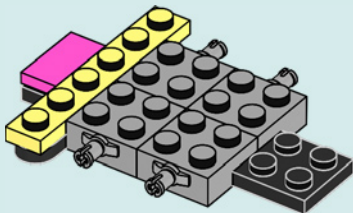



1x

5

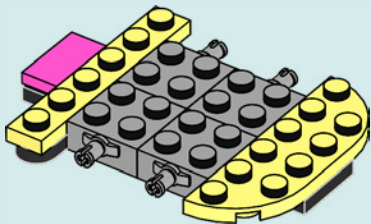



1x

6

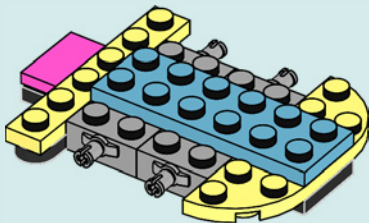



1x



1x

7

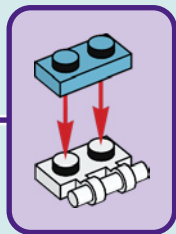
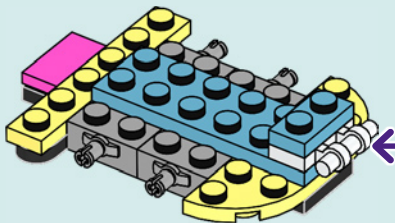



1x

8

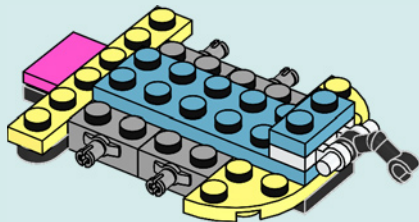



2x

9

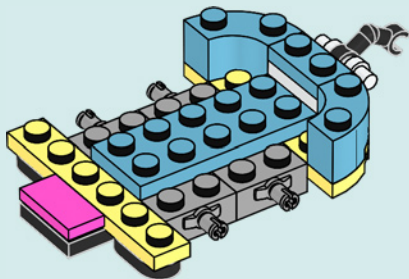

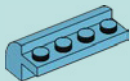

2x

10

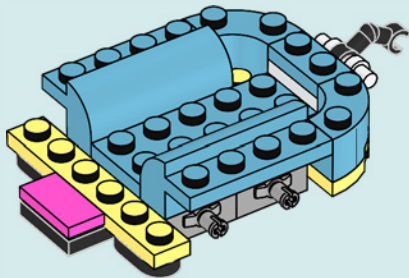



1x



1x

11

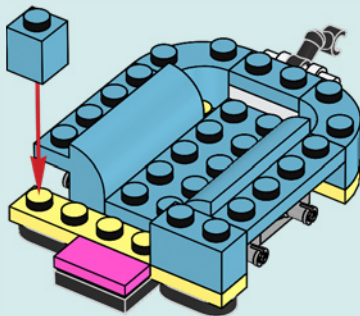

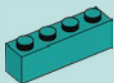

1x

12

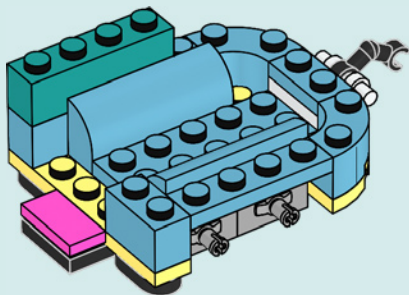



2x



1x

13

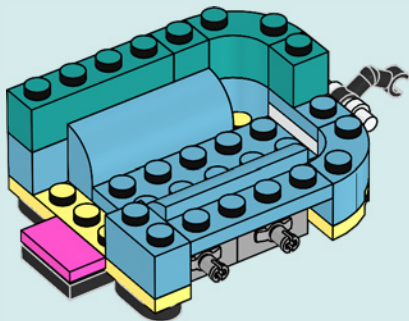



2x



1x

14

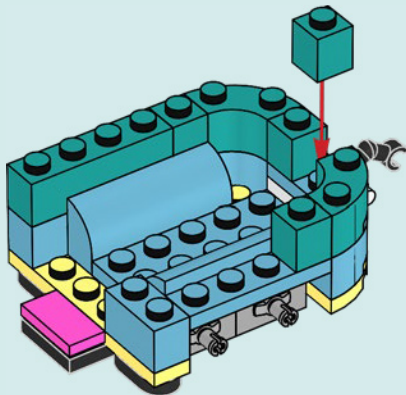

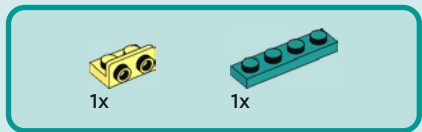
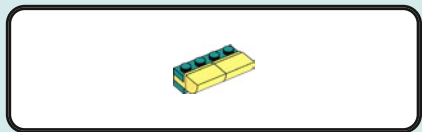

15

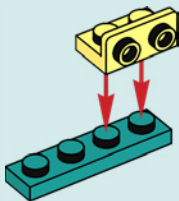



1x

16

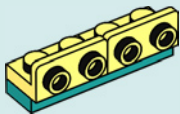



1x

17

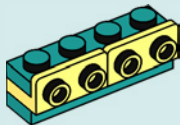



2x

18

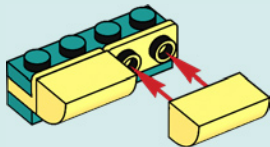

19

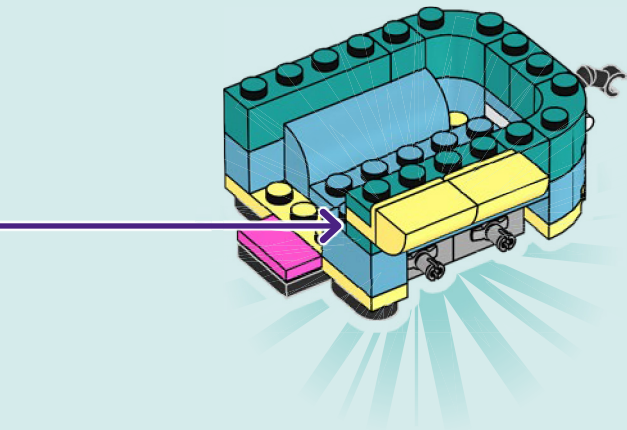



1x

20

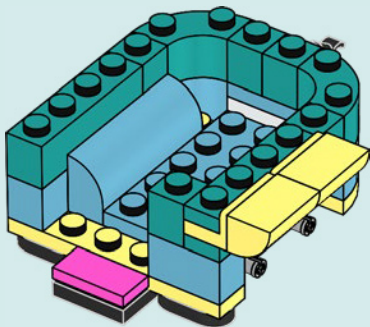



1x

21

1



2



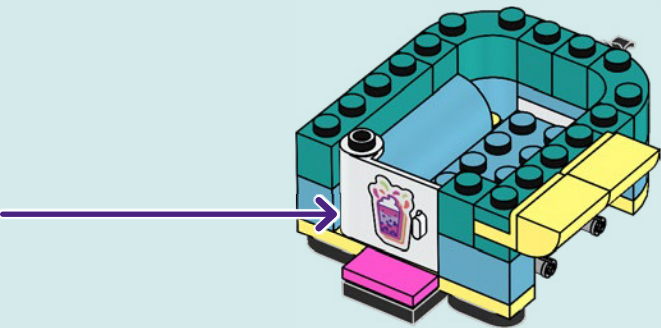



2x

22

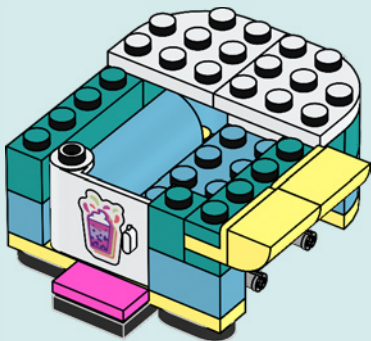



2x



2x

23

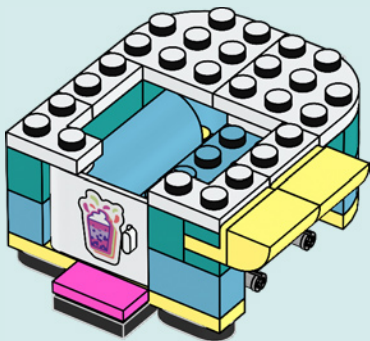



1x

24

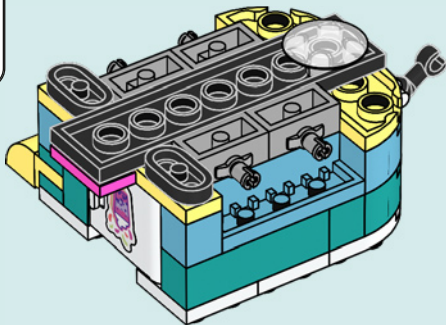



4x



4x

25

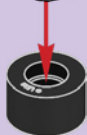
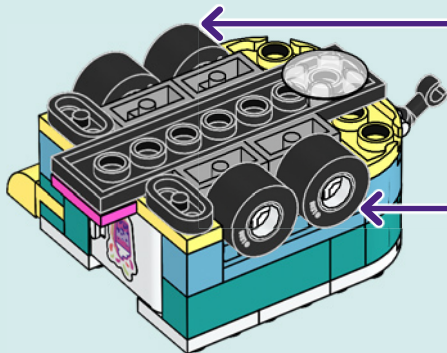

4x





2x



2x

26





1x



1x

27

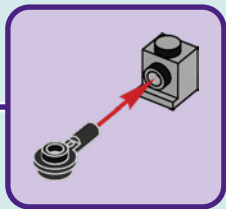
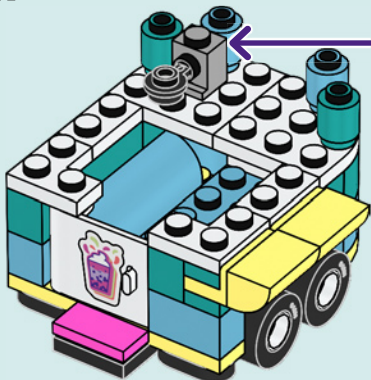



1x



1x

28





1x

29

1



2

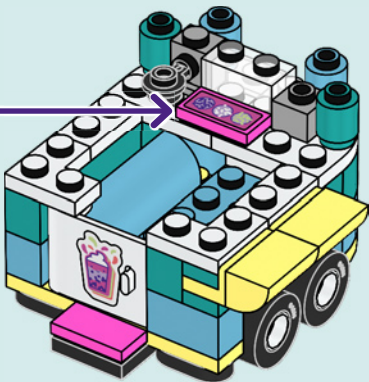



1x

30

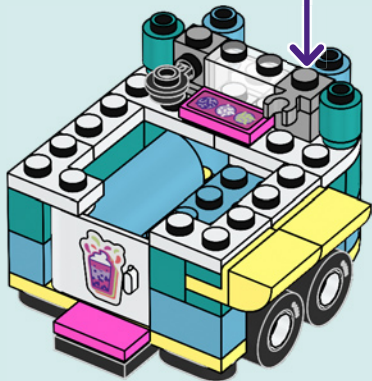



1x



1x

31

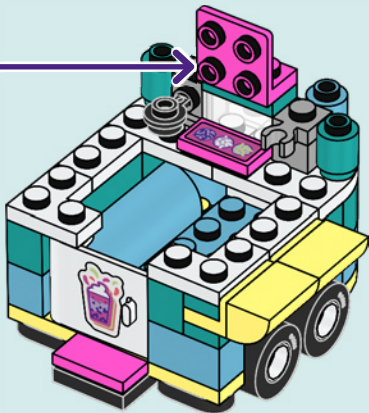
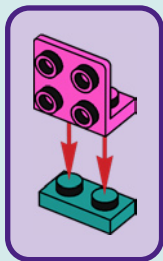



2x

32

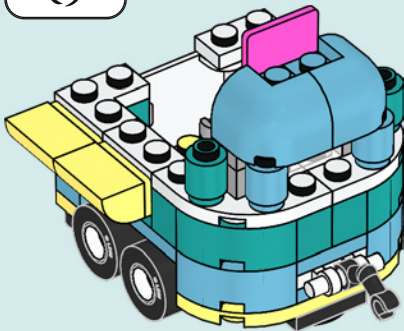



1x

33

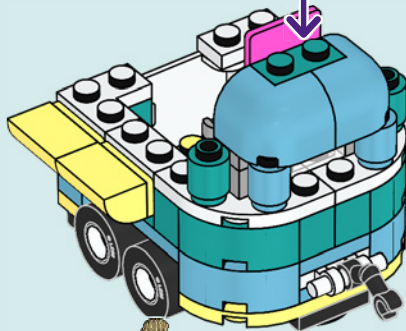
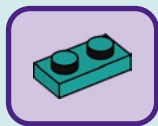



1x

34

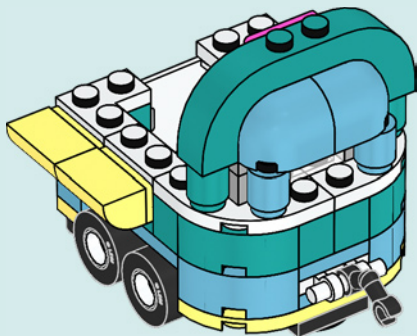



1x



1x

35

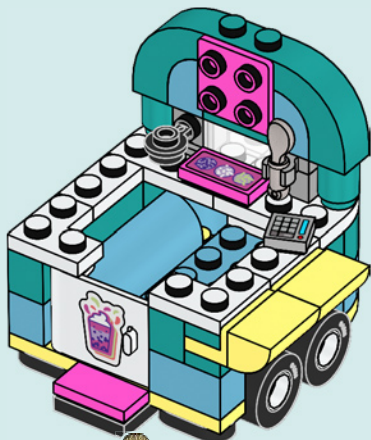



1x



1x



1x

36

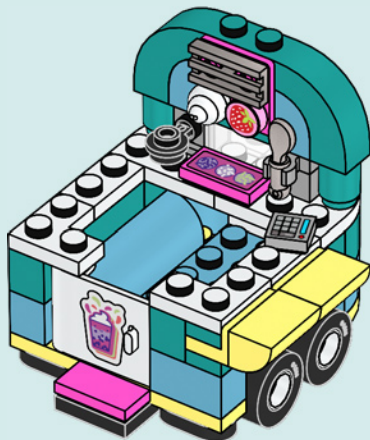

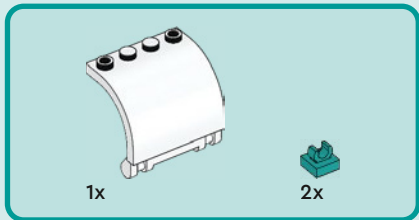

37

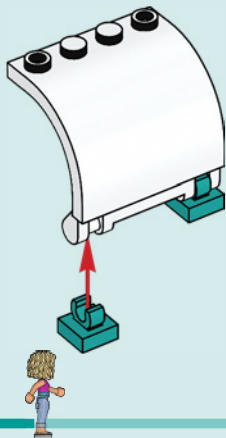

38

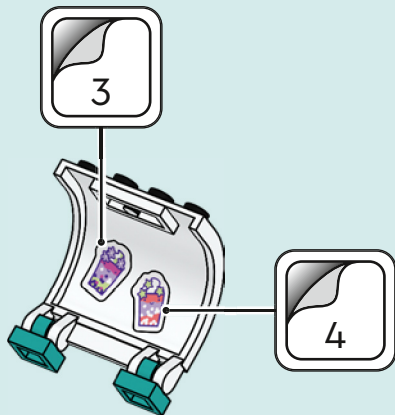

39

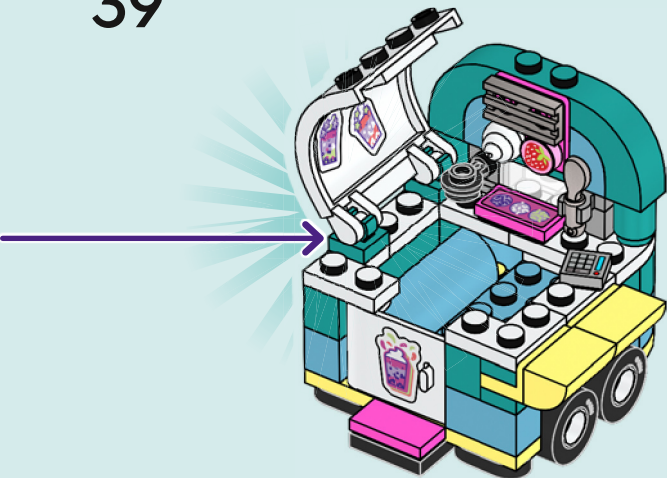



2x

40

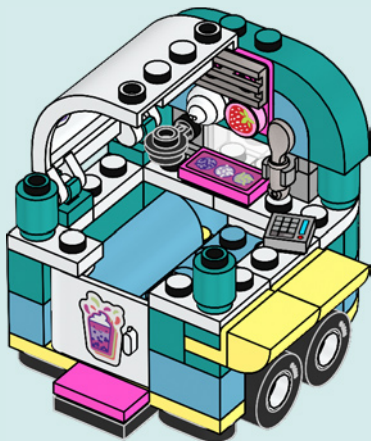



1x

41

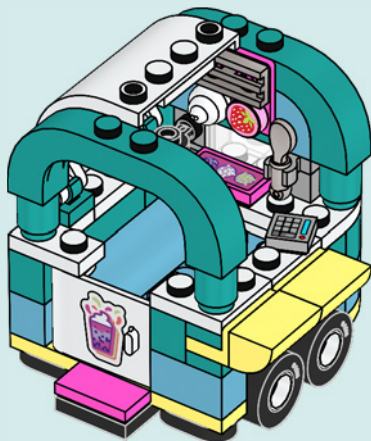



1x



1x

42

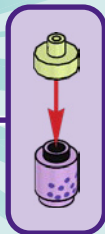
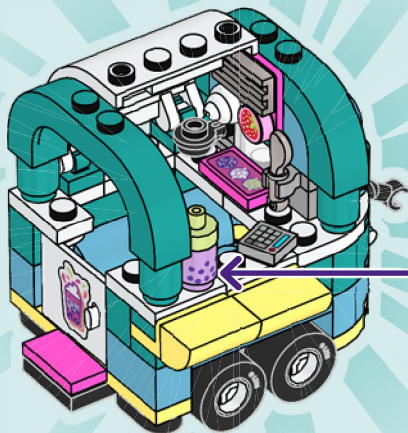

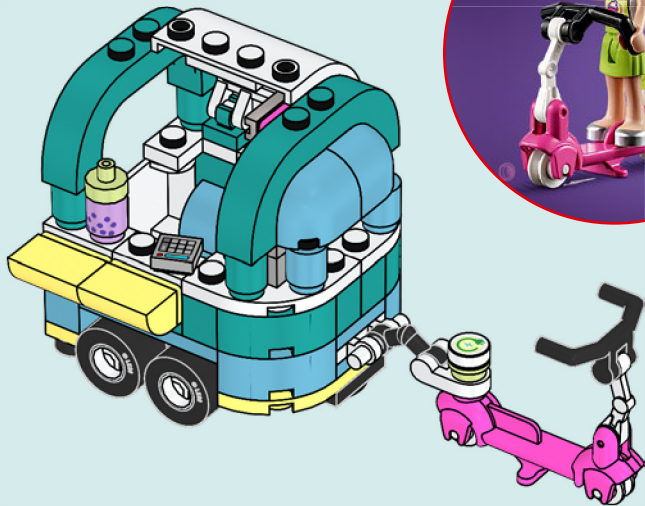



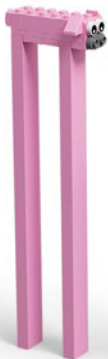

Rebuild
the
world™





Friends

AUTUMN

ALIYA

PAISLEY

ZAC



























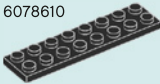



















LEO

LIANN

OLLY

NOVA

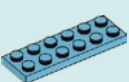

 1x 6234807	 2x 302301	 1x 6409761	 4x 4508215	 2x 6176171	 4x 6325955
 1x 6373413	 1x 6321345	 1x 6416619	 1x 6078610	 1x 6097419	 5x 6213776
 2x 6292800	 1x 4140583	 1x 6423058	 1x 303426	 1x 6092674	 2x 6355014
 2x 4296997	 2x 242001	 1x 6418003	 2x 6210270	 2x 6345199	 2x 6325429
 4x 6011380	 1x 6296037	 1x 6163901	 1x 6196548	 2x 6345200	 2x 6213777
 1x 6252744	 2x 4550745	 1x 6273152	 1x 6326681	 2x 6345200	 1x 6217660
 1x 6174937	 1x 6102937	 1x 6244904	 2x 4620909	 1x 6146926	 2x 6350418
 1x 6284507			 1x 4619652	 1x 6146926	 2x 6383990



1x
4211476



1x
6329583



1x
6401023



1x
6296894



4x
6371448



1x
6196796



1x
4619636



1x
6416621



1x
4549990



1x
6133845



2x
6296494



2x
6296496



1x
6147709



1x
6211356



1x
6423342



1x
6416593



2x
6056381



1x
6422440



1x
6422091



2x
6223767



1x
6287844



1x
6057898



1x
6223506



1x
6427927



2x
6416592



1x
6421379



2x
6421382



LEGO.com/service



YOU COULD

WIN



Scan this QR code or go to
LEGO.COM/PRODUCTFEEDBACK
and give us your short feedback
about this LEGO® set for a chance to
win a cool LEGO prize.

Terms and Conditions apply*

DE: Du könntest GEWINNEN. Es gelten die Teilnahmebedingungen* **FR: Tu pourrais GAGNER.** Des conditions s'appliquent* **IT: Potresti VINCERE tu.** Termini e condizioni sono applicabili* **ES: Puedes GANAR.** Aplican términos y condiciones* **PT: Poderá GANHAR.** Aplicam-se termos e condições* **JA: プレゼント付き! 利用規約が適用されます*** **ZH: 轻松获奖. 条款和条件适用*** **KO: 상품의 주인이 되어보세요. 소정의 약관이 적용됩니다*** **RU: Вы можете ВЫИГРАТЬ.** Действуют положения и условия* **PL: Szansa na WYGRANĄ.** Obowiązują warunki korzystania* **CS: Máte šanci VYHRÁT.** Platí všeobecné smluvní podmínky* **SK: Máte šancu VYHRAŤ.** Platia všeobecné zmluvné podmienky* **HU: TE IS NYERHETSZ.** Felhasználási feltételek érvényesek* **RO: Ai putea CÂȘTIGA.** Se aplică termenii și condiții* **BG: Можете да СПЕЧЕЛИТЕ.** Има определени правила и условия* **LV: Tu vari LAIMĒT.** Ir spēkā noteikumi un nosacījumi.* **ET: Sul on võimalus VÕITA.** Kehtivad tingimused* **LT: Jūs galite LAIMĖTI.** Taikomos sąlygos*

*[LEGO.com/productfeedback-terms](https://www.lego.com/productfeedback-terms)

LEGO, the LEGO logo and the FRIENDS logo are trademarks of the/son des marques de commerce du/son marcas registradas de LEGO Group. ©2023 The LEGO Group.

6444331