



# Friends

41755



**WARNING: CHOKING HAZARD.**  
Toy contains small parts and a small ball.  
Not for children under 3 years.



### **Get excited about our new packaging!**

We're switching from plastic to paper-based packaging. That's why you might find a mix of paper and plastic in our boxes!

### **Nos nouveaux emballages vous emballeront !**

Nous passons des emballages en plastique aux emballages à base de papier. C'est pourquoi vous pourriez trouver un mélange de papier et de plastique dans nos boîtes !

### **¡Te presentamos nuestros nuevos empaques!**

Estamos sustituyendo las bolsas de plástico por bolsas con base de papel. ¡Por eso, puedes encontrar una mezcla de papel y de plástico en nuestras cajas!

**[LEGO.com/sustainable-packaging](https://www.lego.com/sustainable-packaging)**

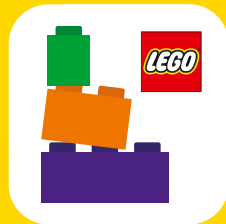

# BUILDER



Apple and the Apple logo are trademarks of Apple Inc., registered in the U.S. and other countries and regions. App Store is a service mark of Apple Inc. Google Play and the Google Play logo are trademarks of Google LLC. Tencent and the Tencent logo are trademarks of Tencent Inc.

Q [LEGO.com/devicecheck](https://www.lego.com/devicecheck)

**EN** Ask parents' permission before going online | **DE** Eltern um Erlaubnis bitten, bevor du online gehst | **FR** Demande l'autorisation d'un parent avant d'aller en ligne | **IT** Chiedi il permesso ai tuoi genitori prima di andare online | **ES** Pídeles permiso a tus papás antes de conectarte a Internet | **PT** Peça autorização aos pais antes de acederes online | **JA** オンラインになる前に ほご者の方のきょかをもらおう | **ZH** 上网前应先征得父母的同意 | **KO** 온라인 접속 전에 보호자 동의가 필요합니다 | **RU** Спроси разрешения у родителей, прежде чем заходить в интернет | **PL** Poproś rodziców o zgodę, zanim wejdiesz do Internetu | **CS** Než půjdeš na internet, požádej rodiče o svolení | **SK** Skôr než pôjdeš na internet, vypýtaj si povolenie od rodičov | **HU** Kérj szülői engedélyt, mielőtt online csatlakoznál! | **RO** Cere permisiunea părinților înainte de a te conecta online | **BG** Поискайте разрешението от родители, преди да влезете онлайн | **LV** Pirms došanās tiešsaistē palūdz atļauju vecākiem | **ET** Enne Interneti kasutamist küsi vanematelt luba | **LT** Prieš prisijungdami prie interneto, atsklaukite tėvų



## AVERTISSEMENT :

RISQUE D'ÉTOUFFEMENT. Le jouet contient des petites pièces ainsi qu'une petite boule. Il ne convient pas aux enfants de moins de 3 ans.



## ADVERTENCIA:

PELIGRO DE ASFIXIA.

Juguete que contiene partes pequeñas y una pelota pequeña. No recomendado para niños menores de 3 años.

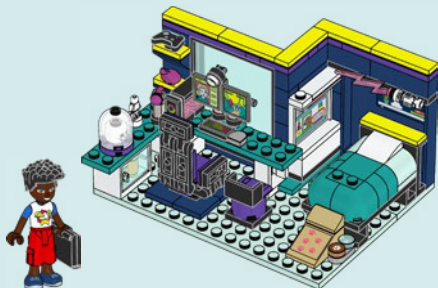
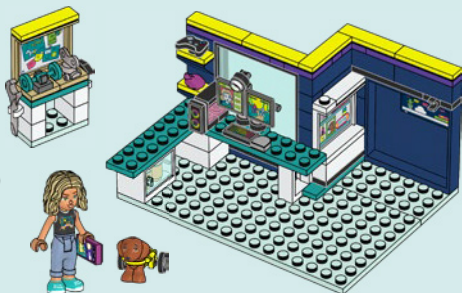



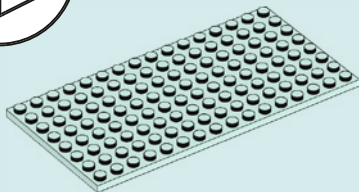

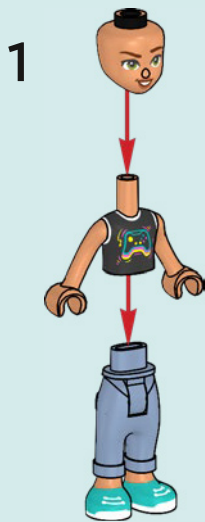

2



**NOVA**





**PICKLE**



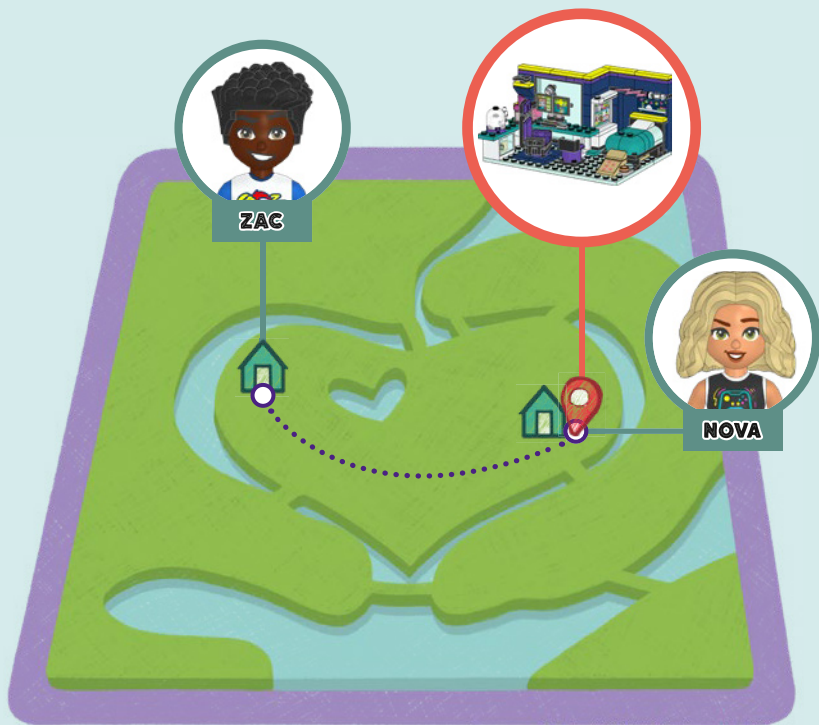



1x



1x

1

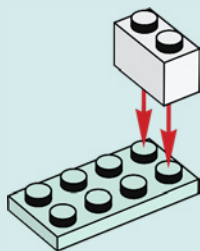





1x

2

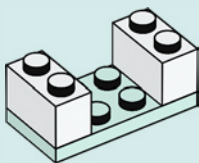

2x

3

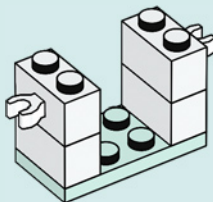



1x

4

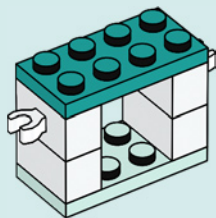

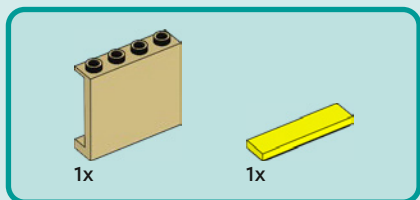

5

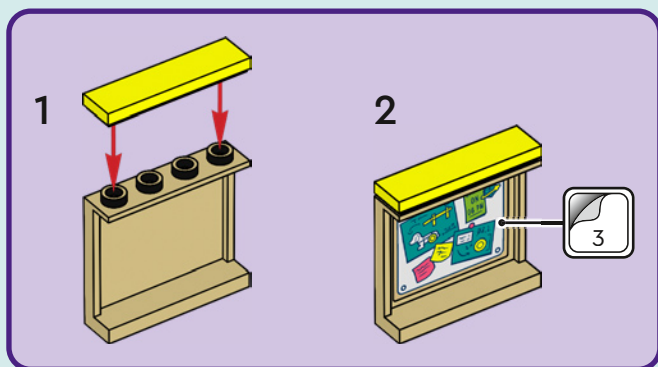



2x

6

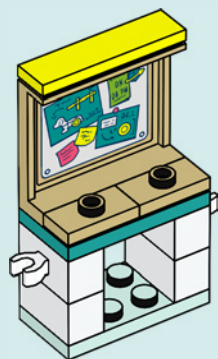



1x



1x

7

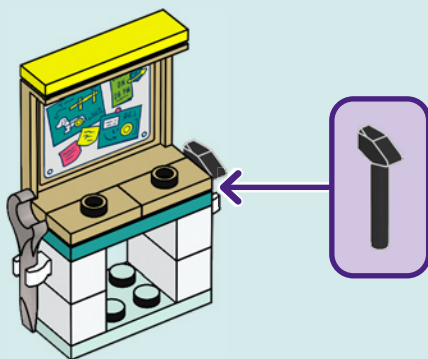



1x



1x

8

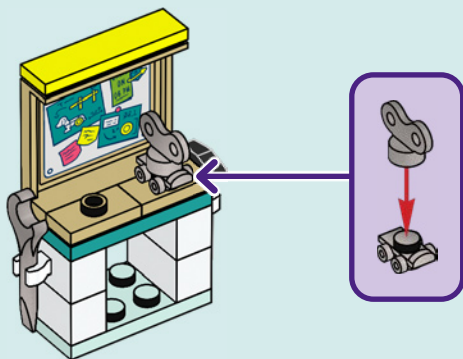





1x



1x

9

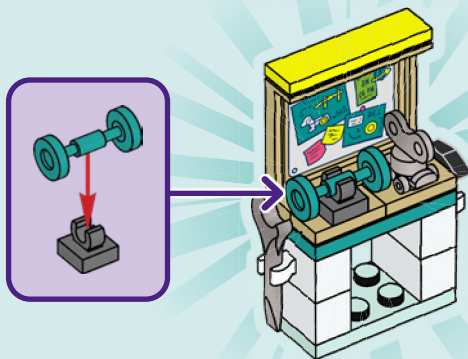

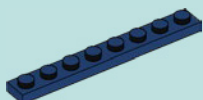
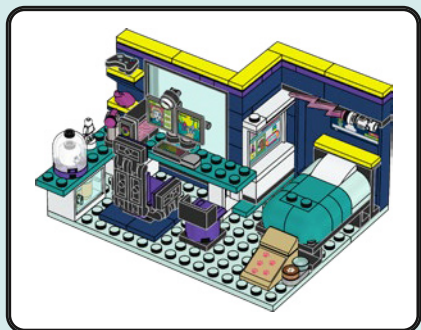

1x

1

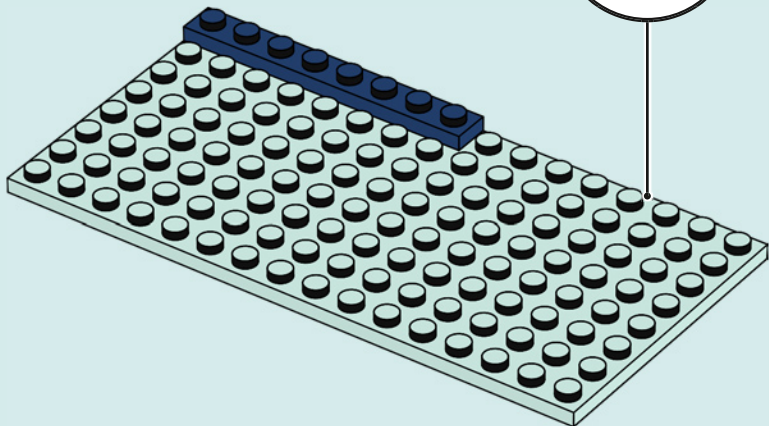
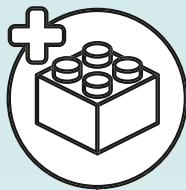



2x

2

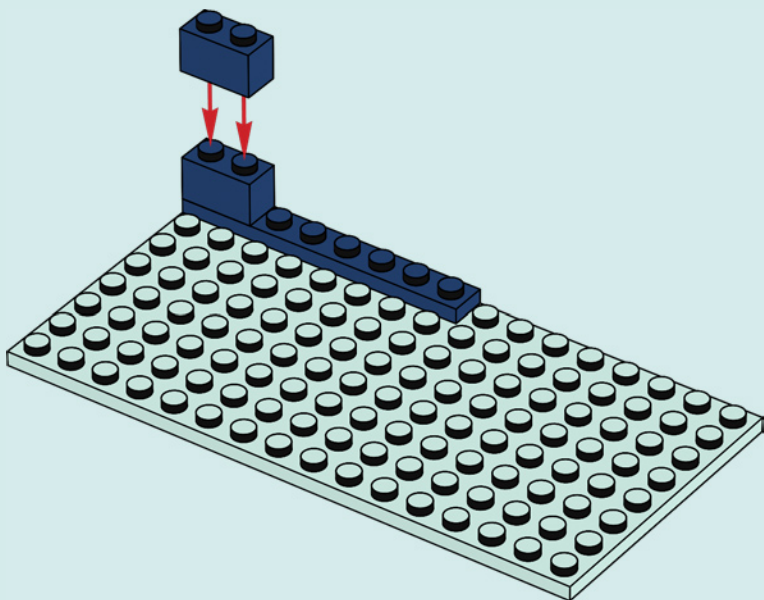



2x

3

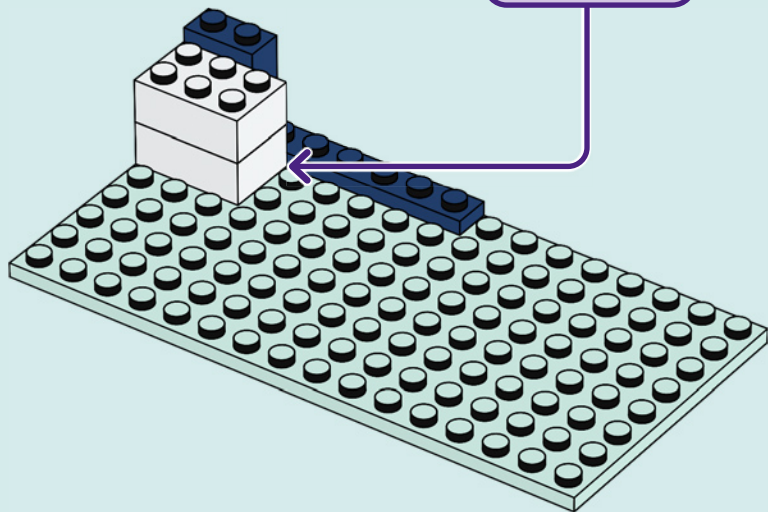
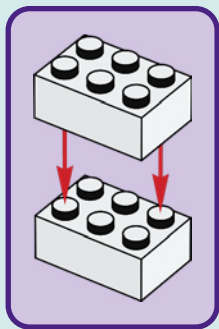

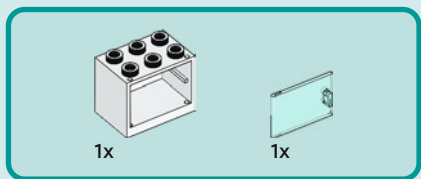

4

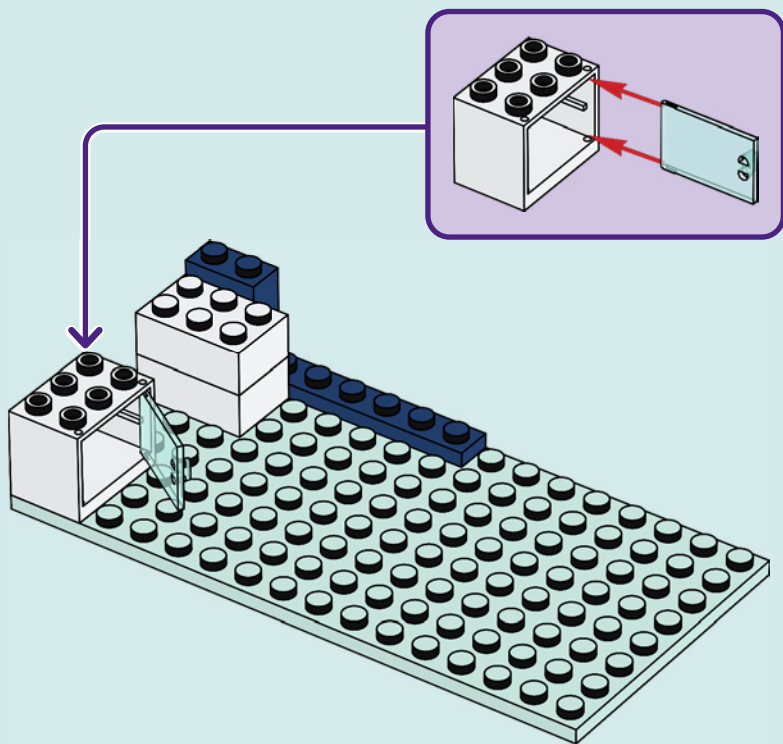



5

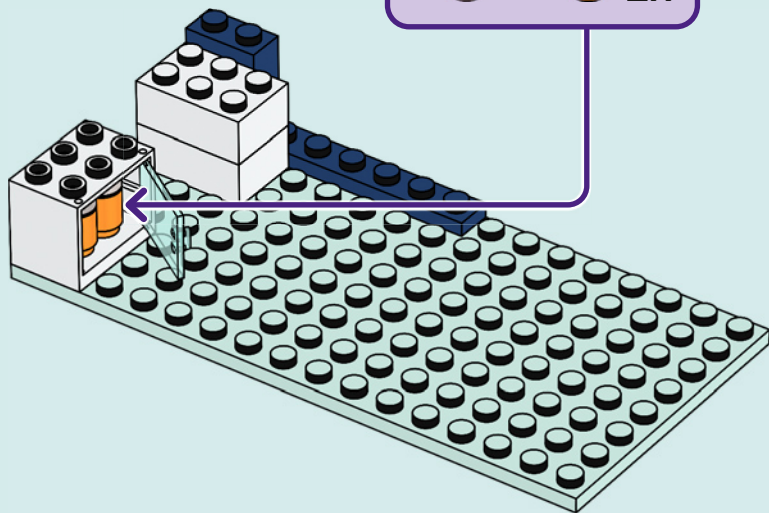
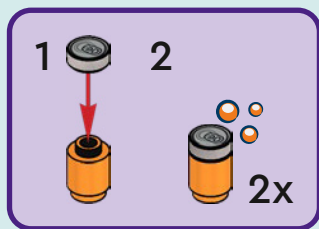



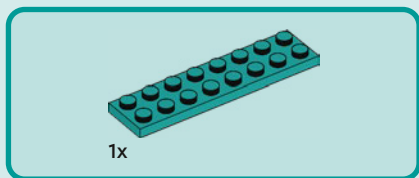

6

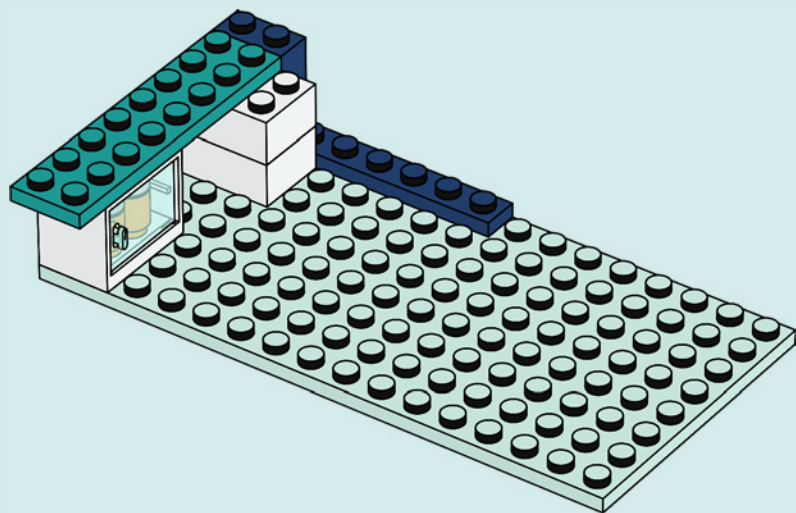

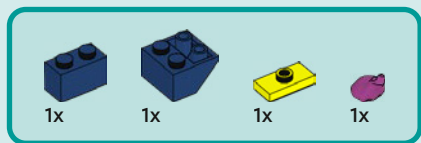

7

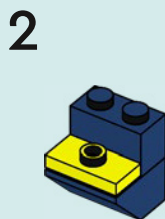
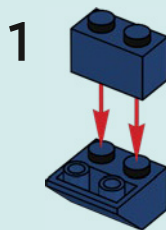

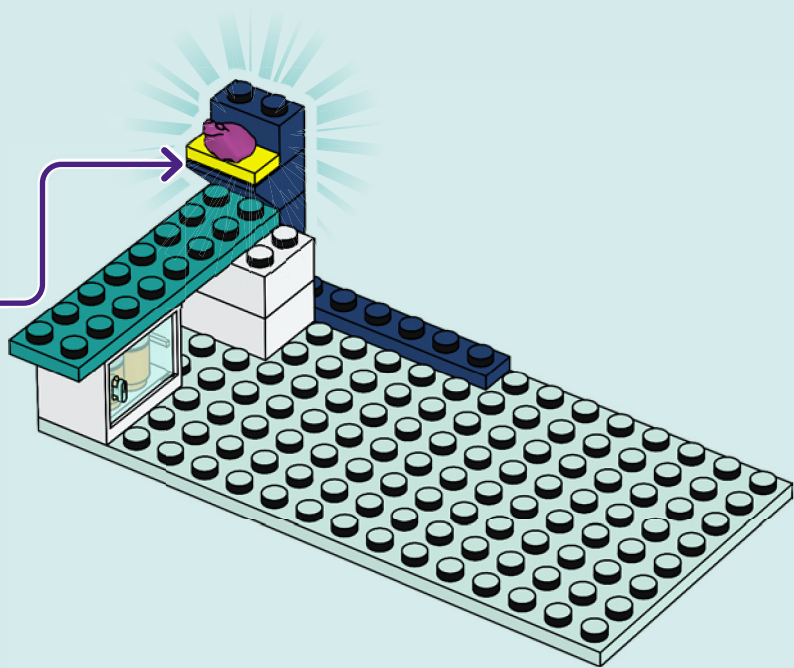



8

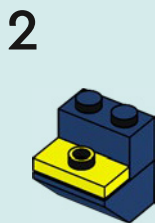
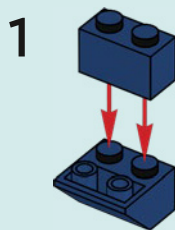

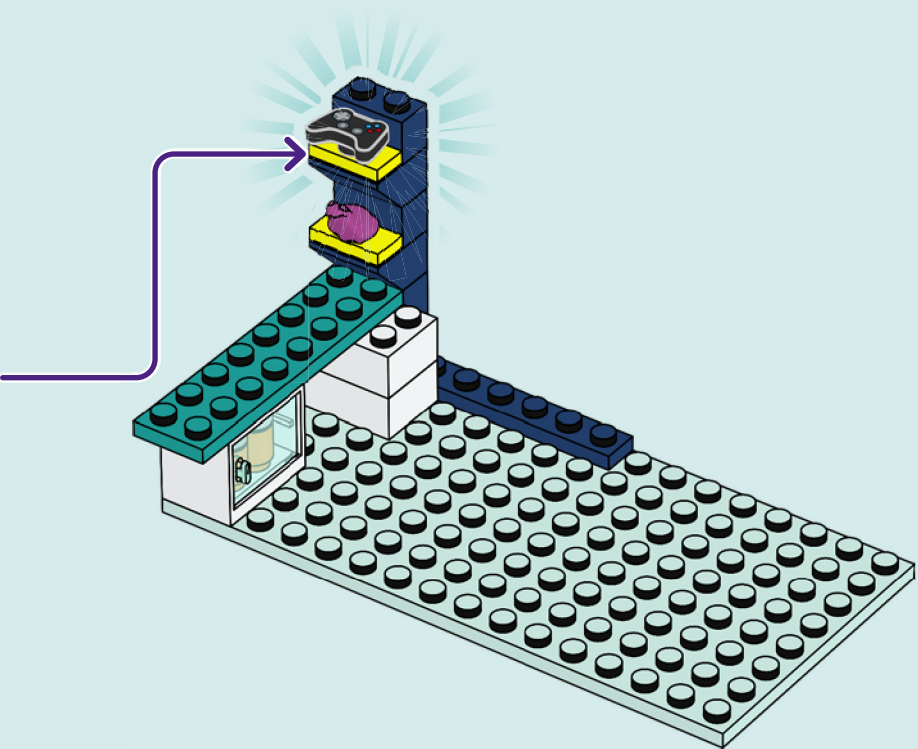

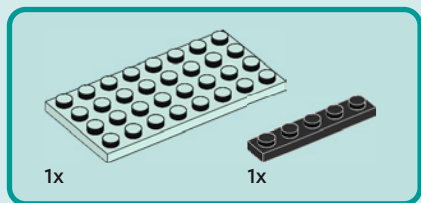

9

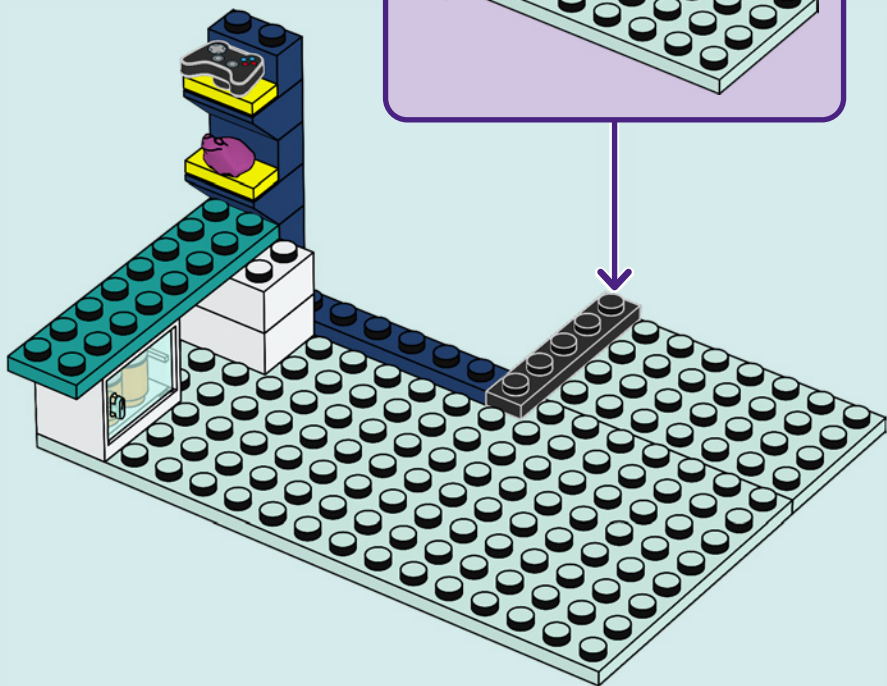
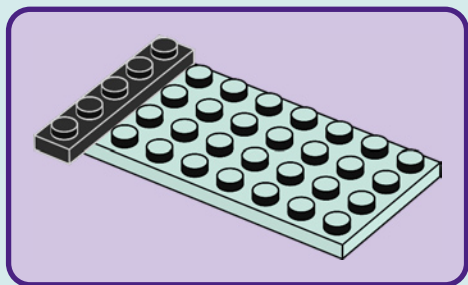

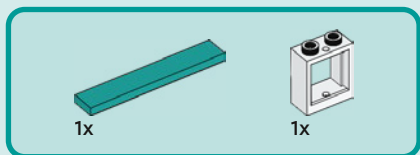

10

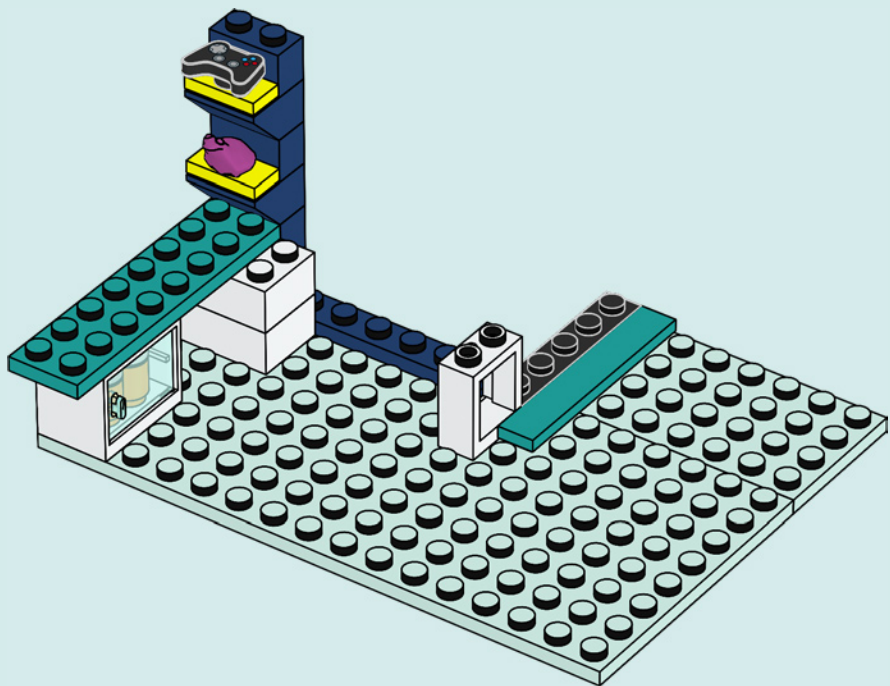

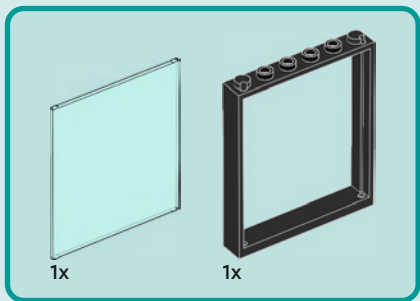

11

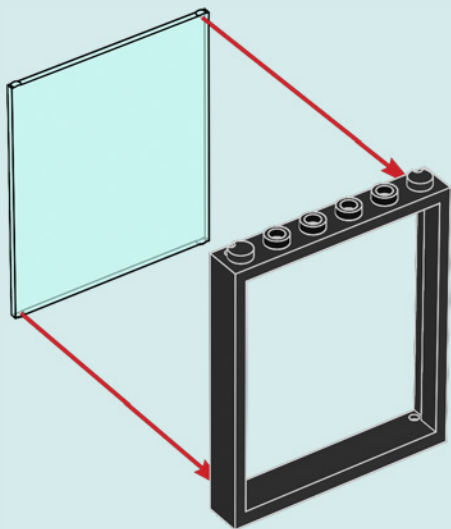



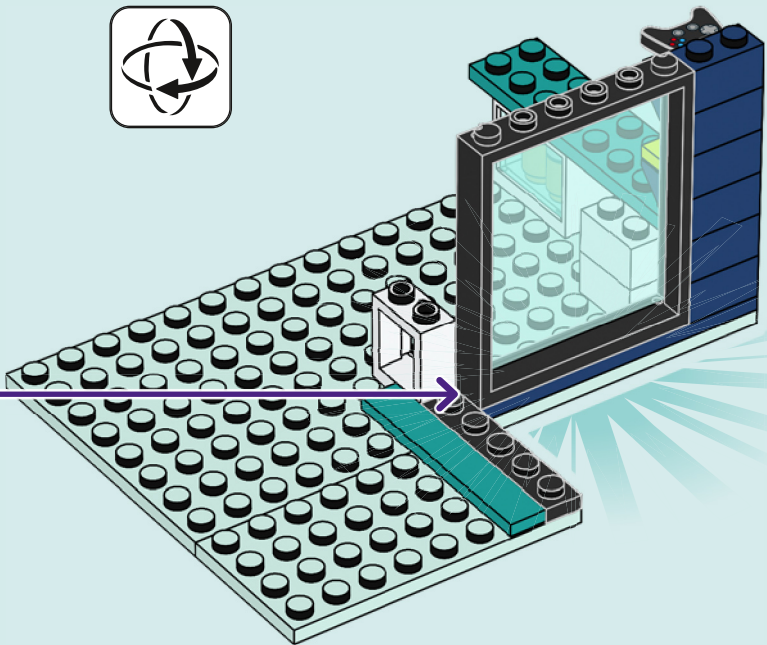

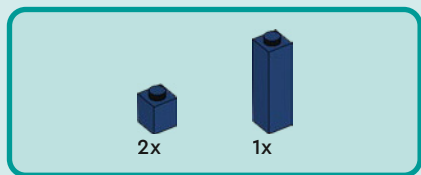

12

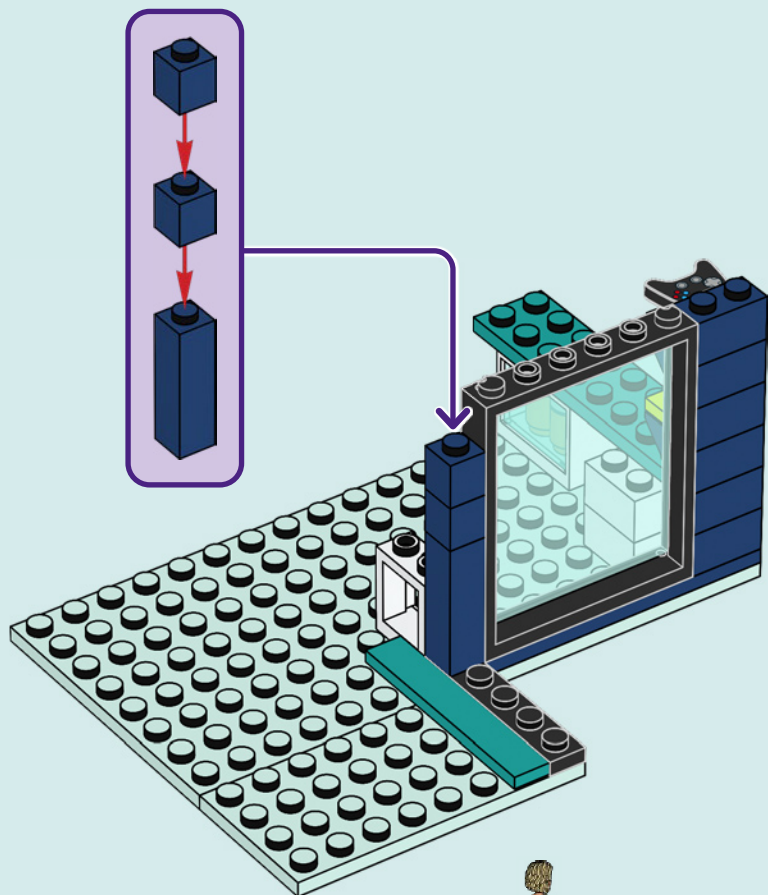



1x

13

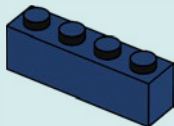

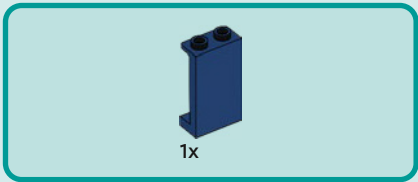

14

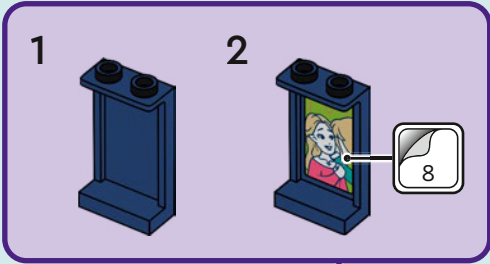



3x

15

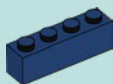
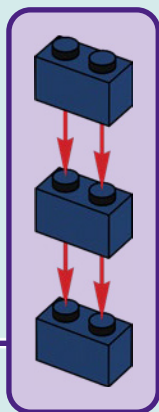

1x

16



17

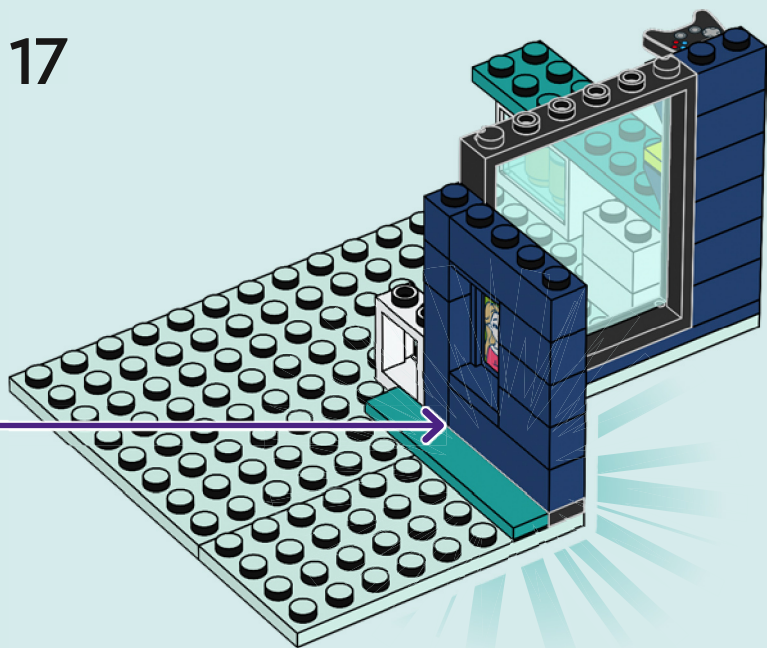

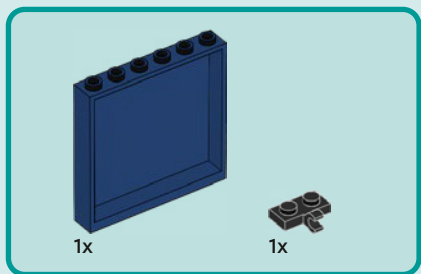
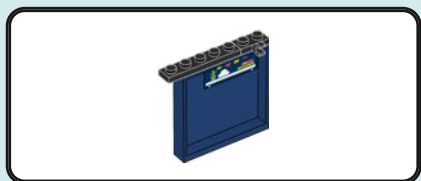

18

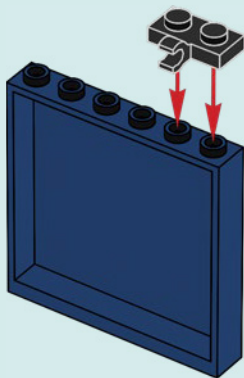



1x

19



20

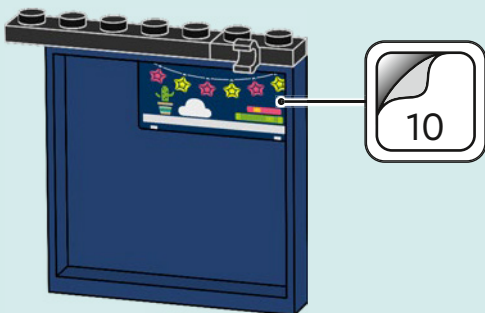





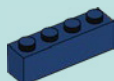

3x

22

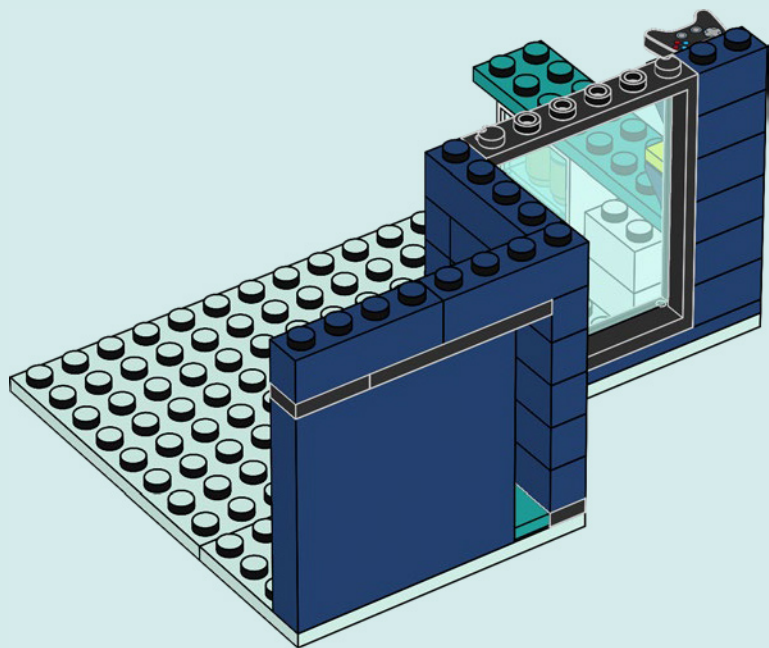

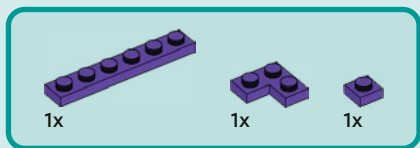

23

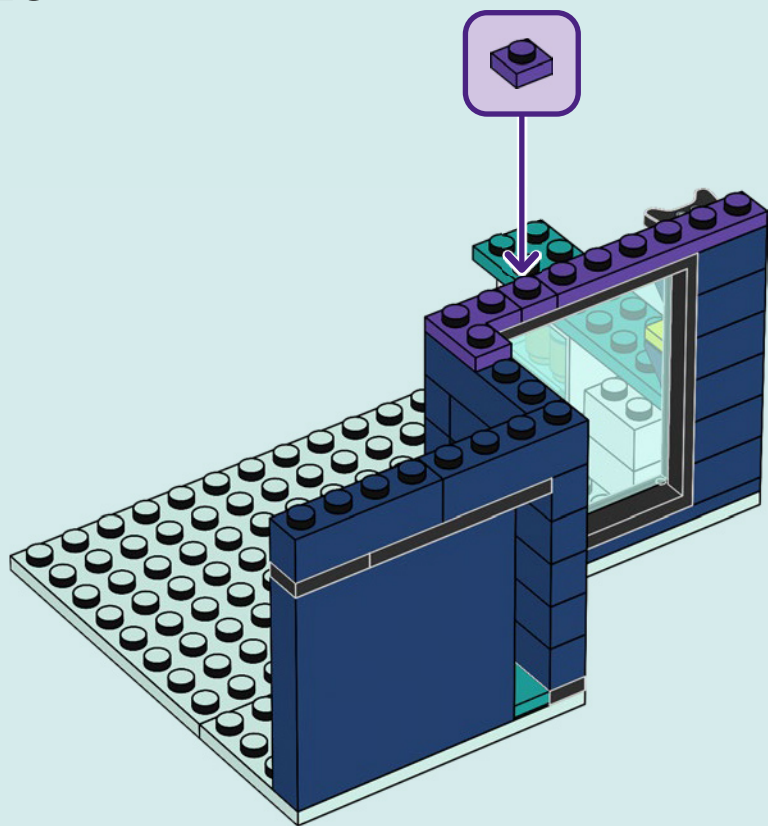

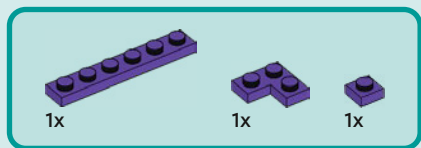

24

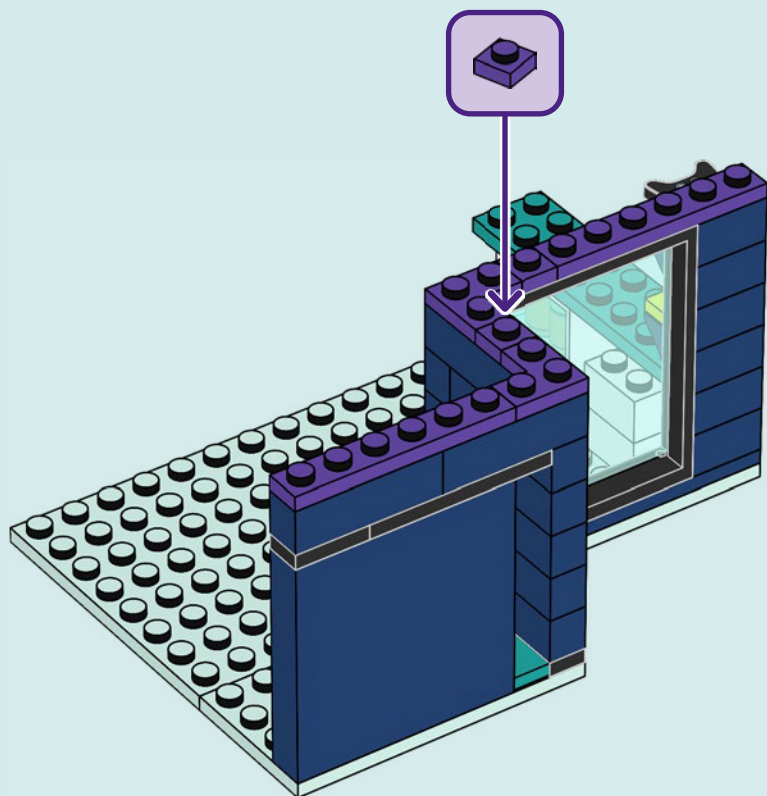



5x

25

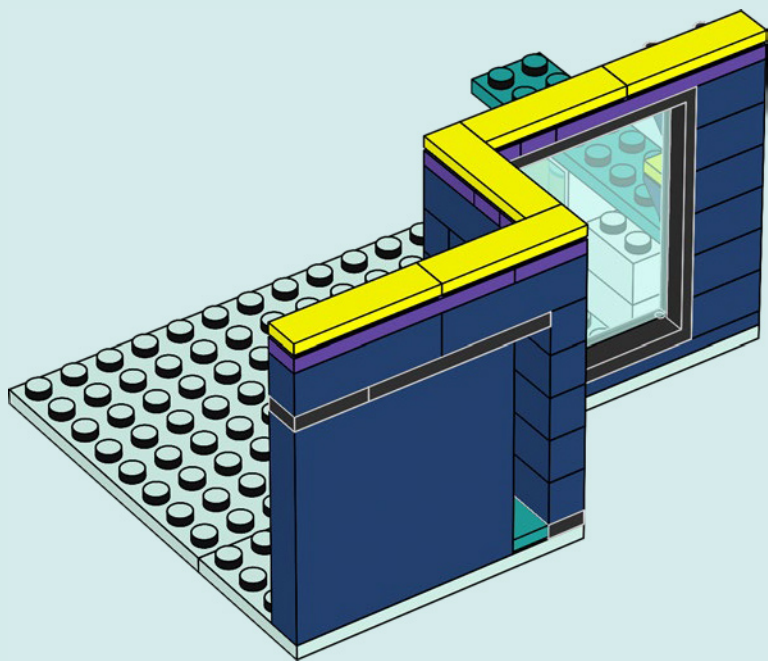

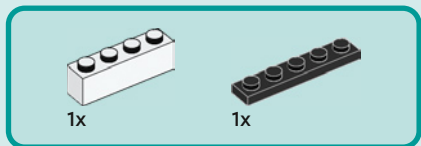
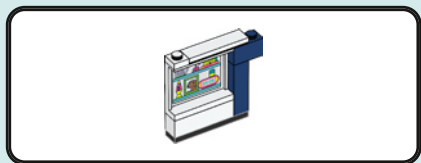

26

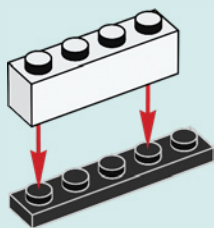



1x

27

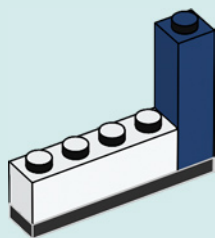

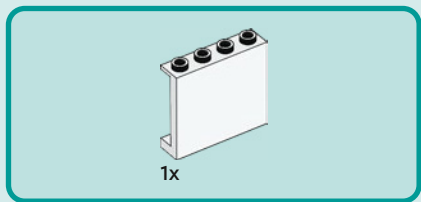

28

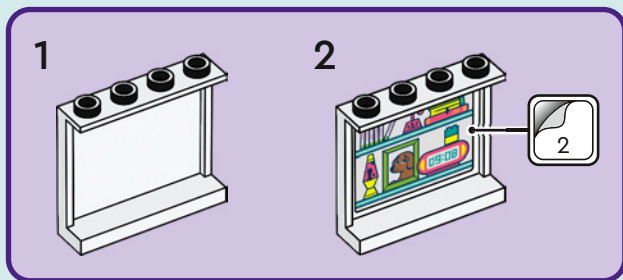





1x

29





1x



1x

# 30

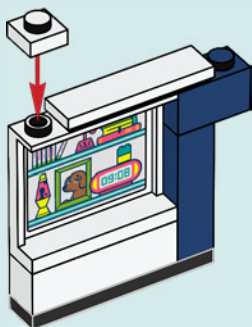

31

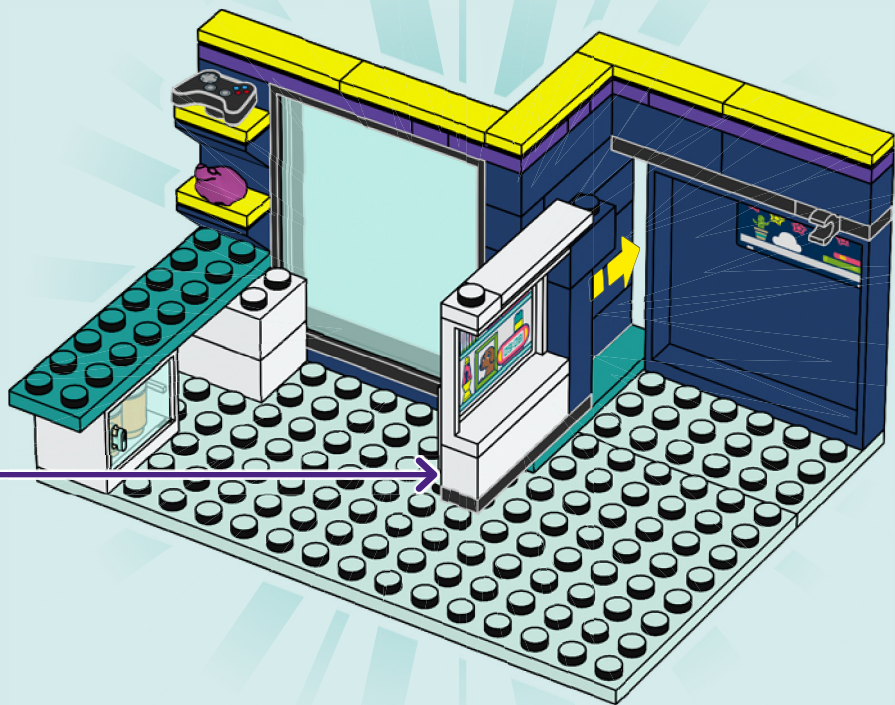



1x

32

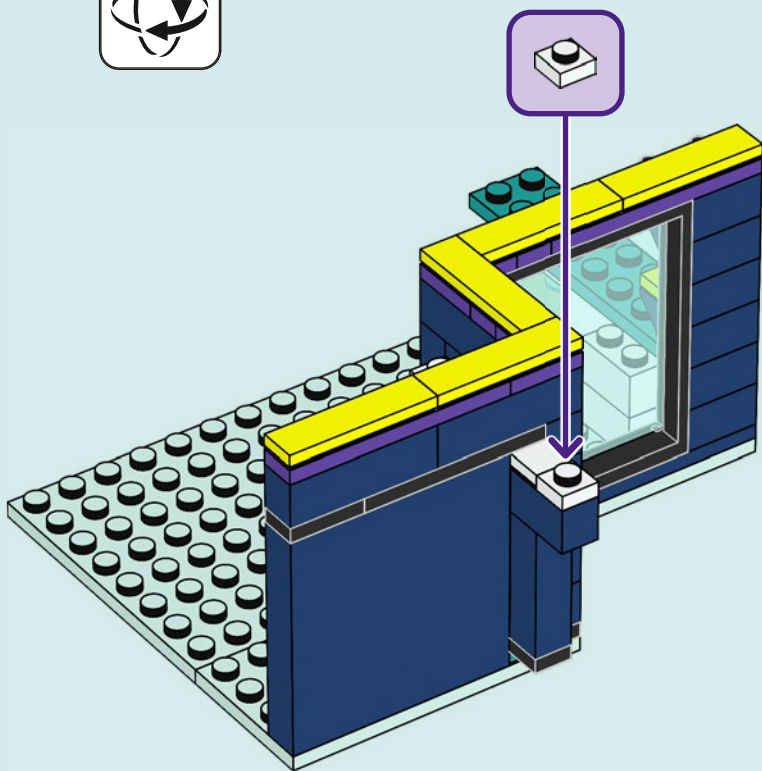

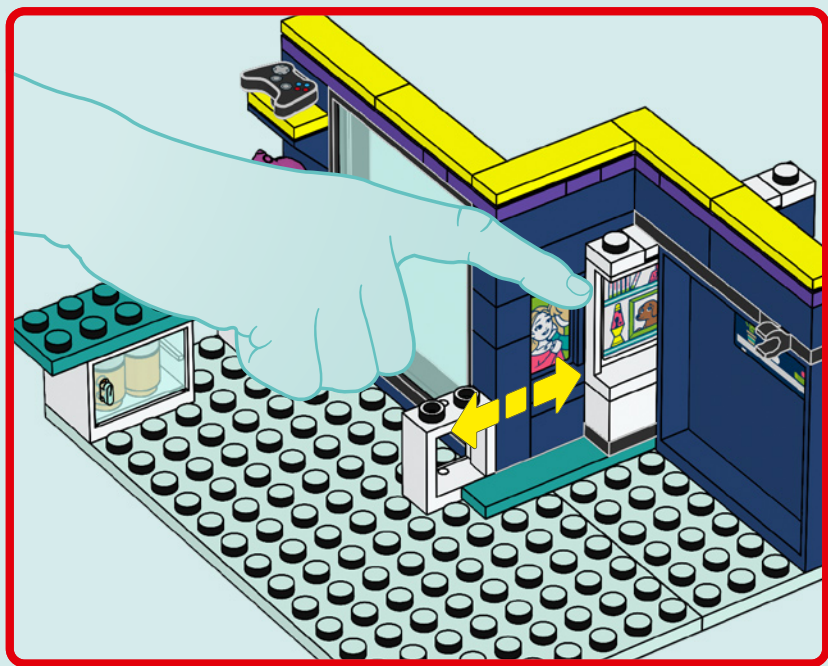



1x

33

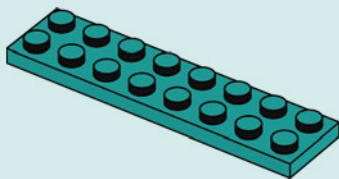

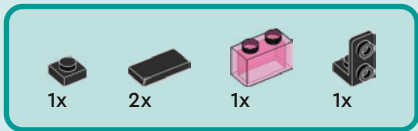

34

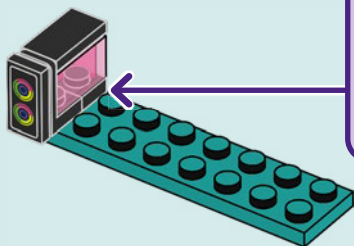
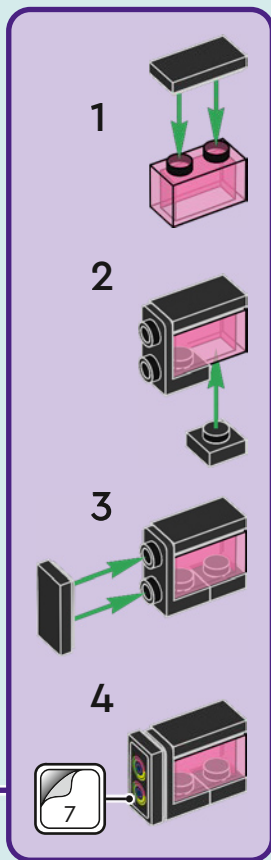



# 35

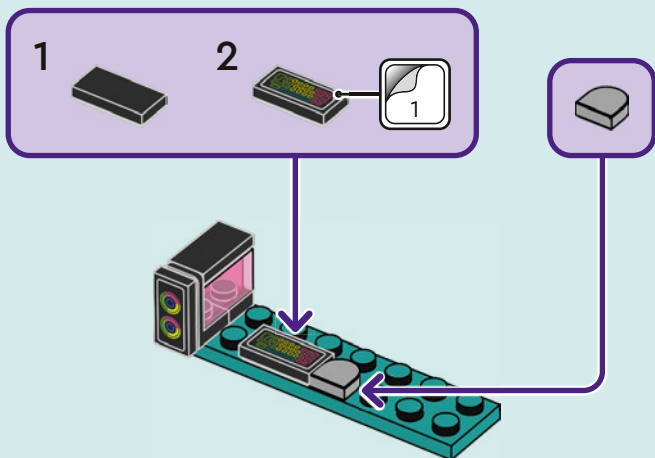





2x



1x



2x

# 36

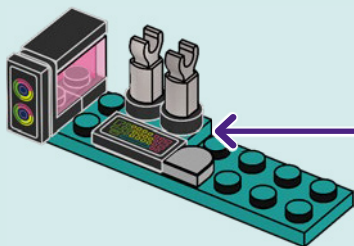
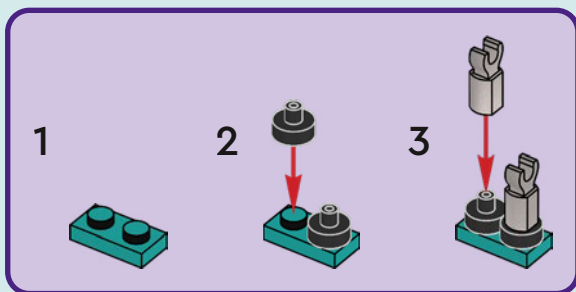

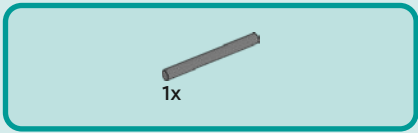

37

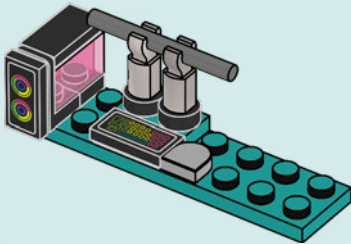



2x

# 38

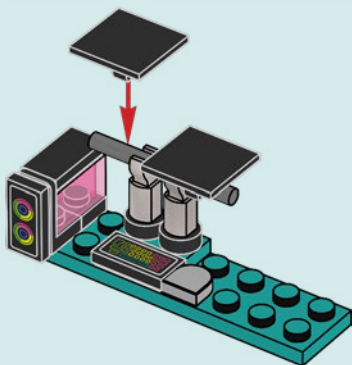

# 39

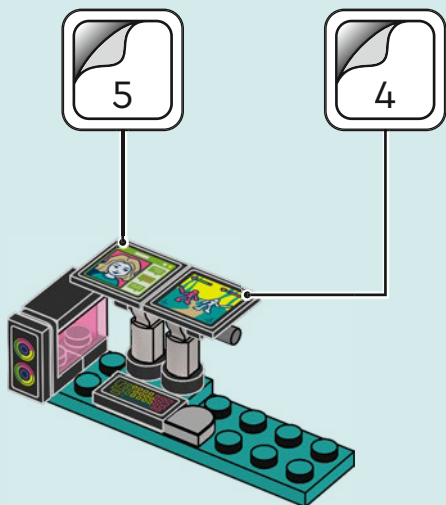



# 40

1



2



3

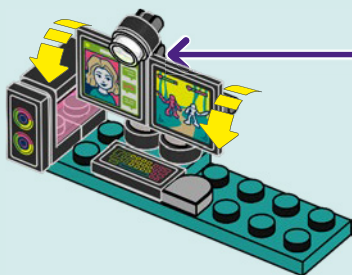

41

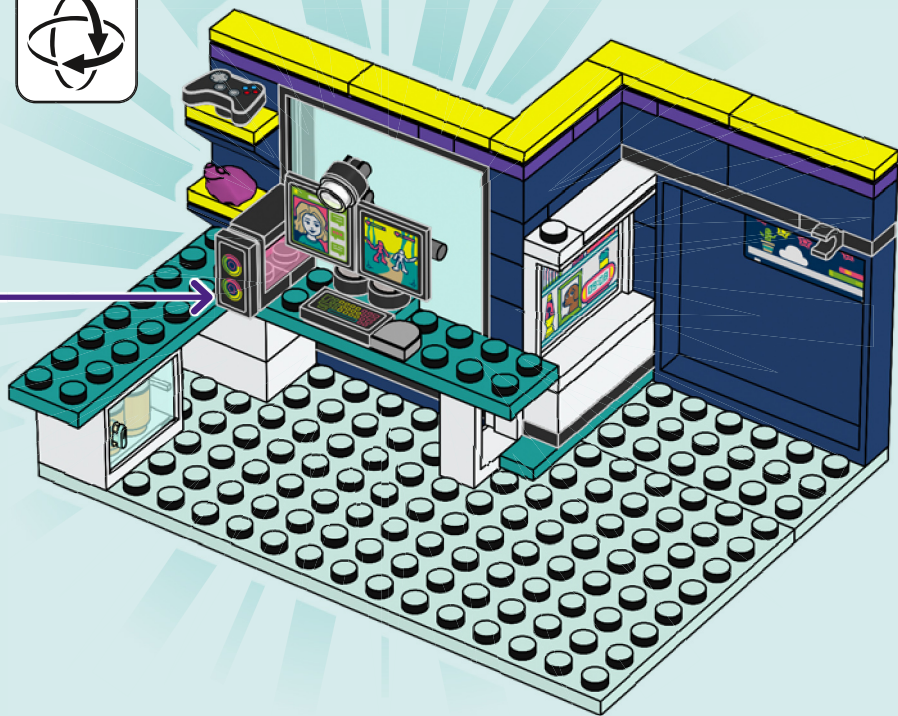



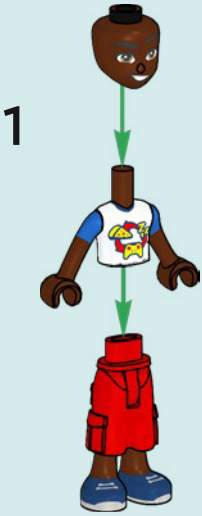
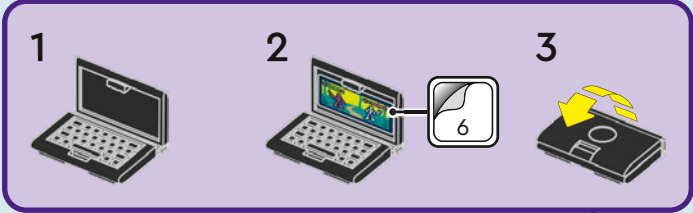



ZAC



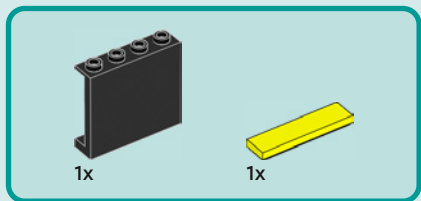

42

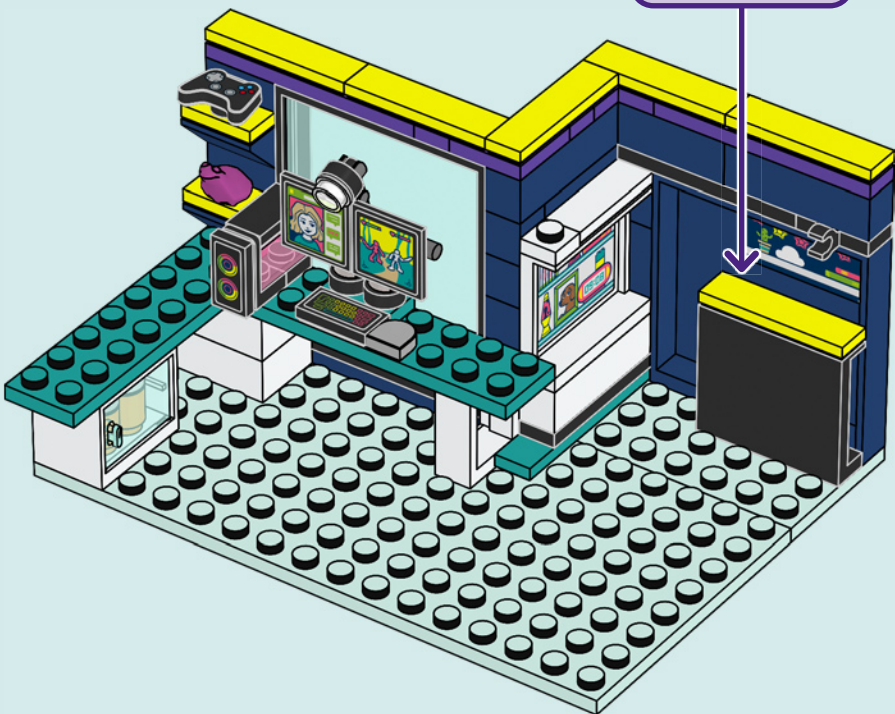
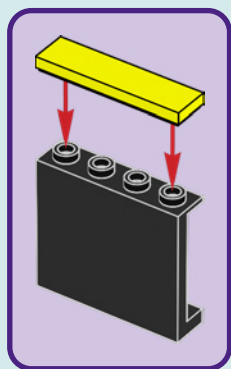



1x



1x

# 43

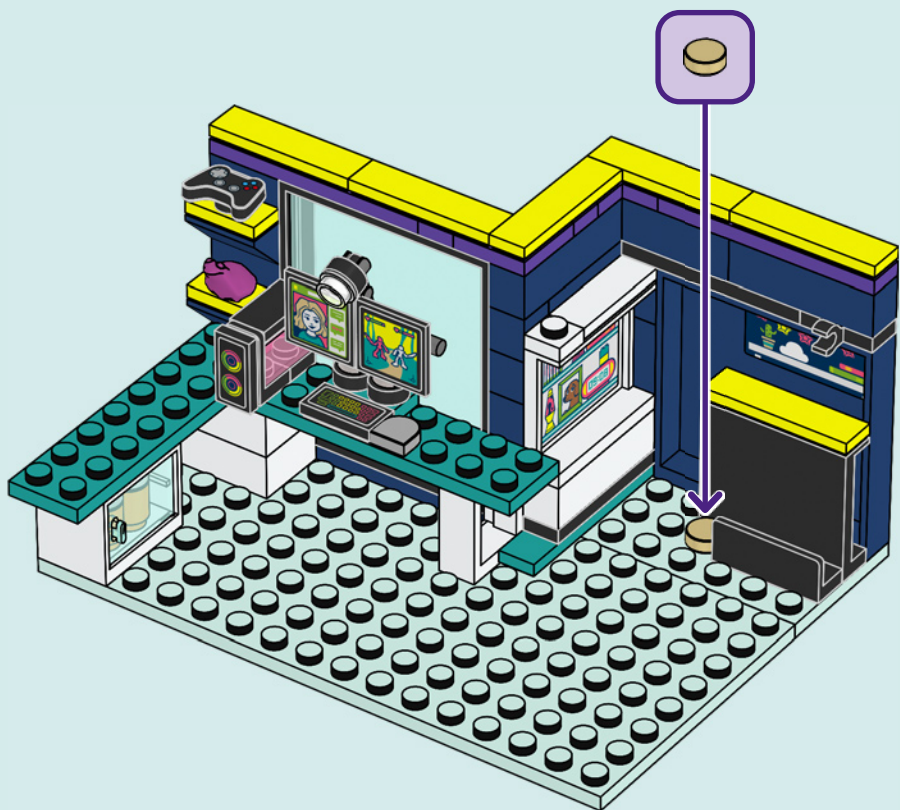



2x

44

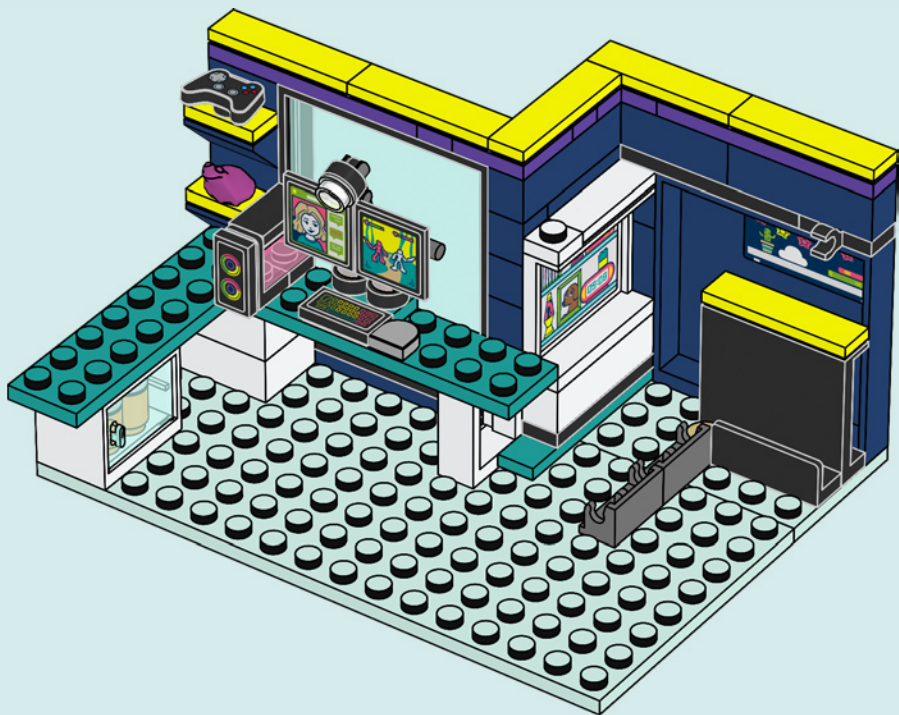



1x

45

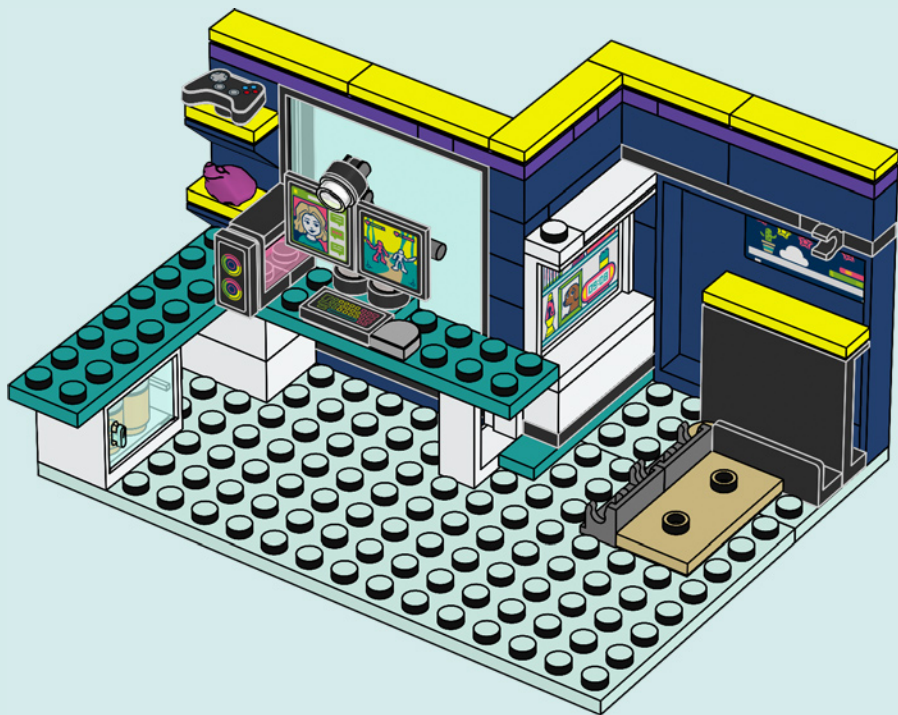





1x



1x

# 46

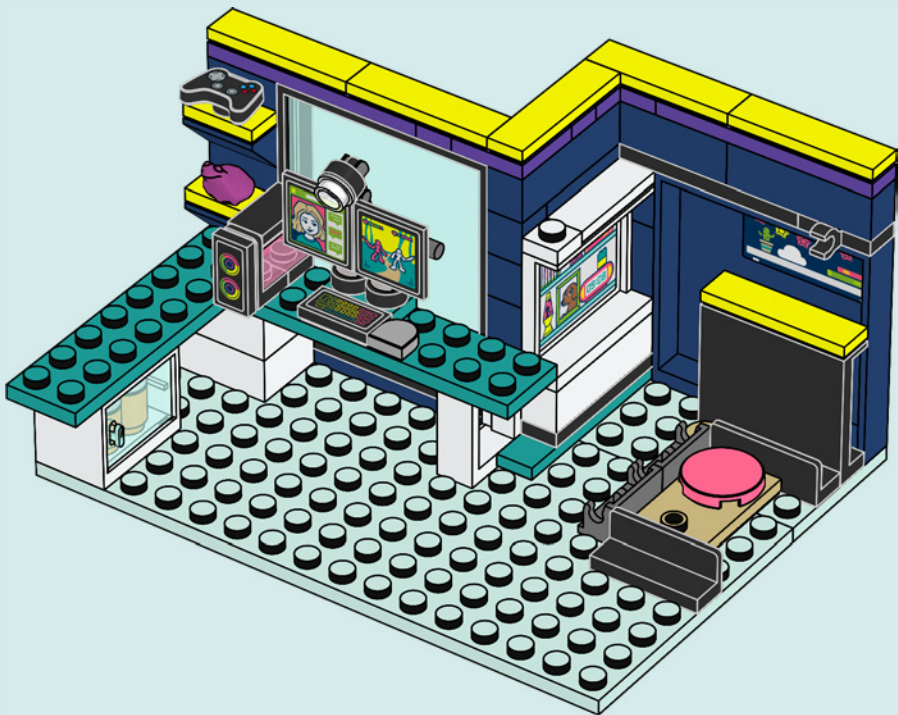

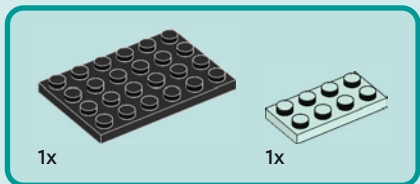
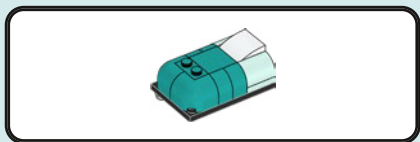

47

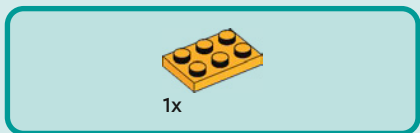
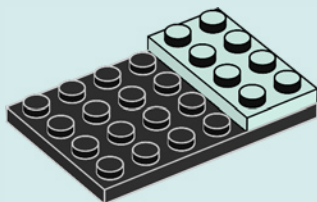

48

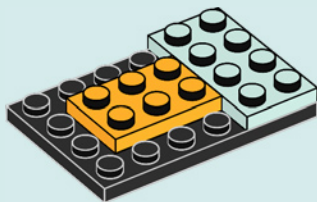



1x



1x

# 49

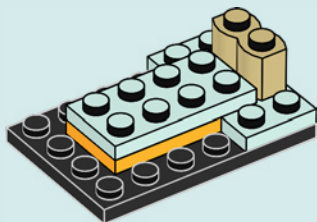

1x



2x

# 50

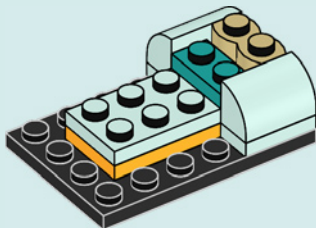





4x

# 51

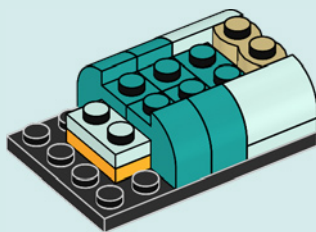

2x

# 52

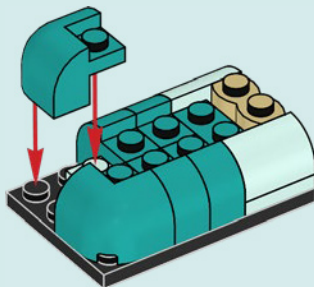

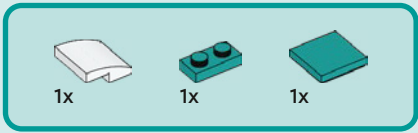

53

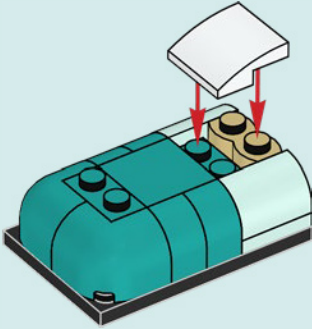

54

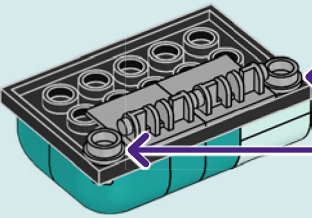

55

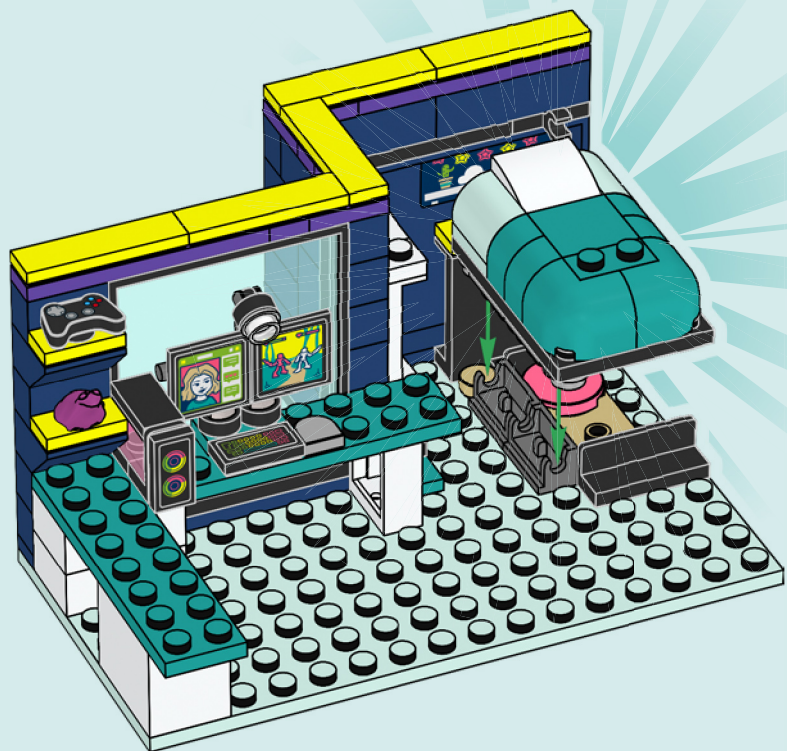



1x

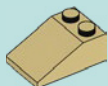

1x

# 56

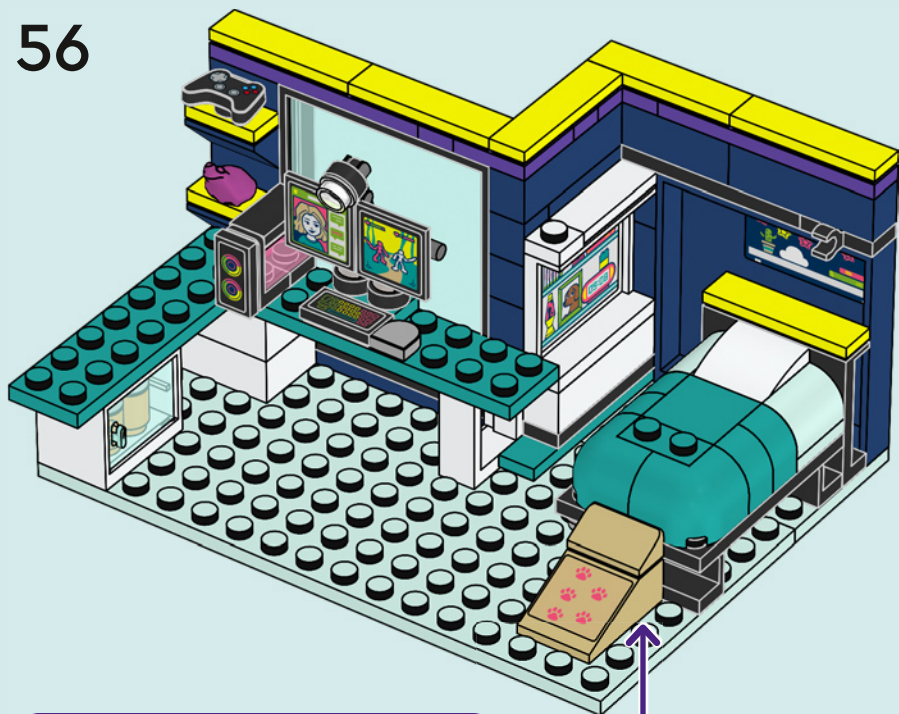

1

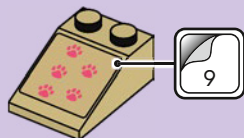

2

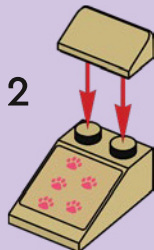



1x



1x



1x

57

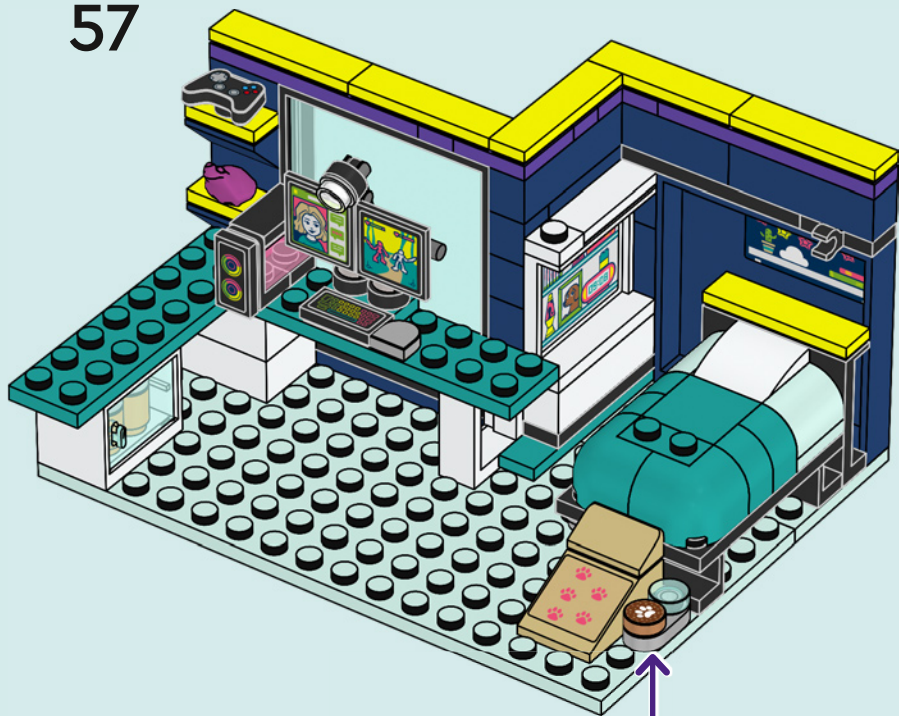

1



2





58

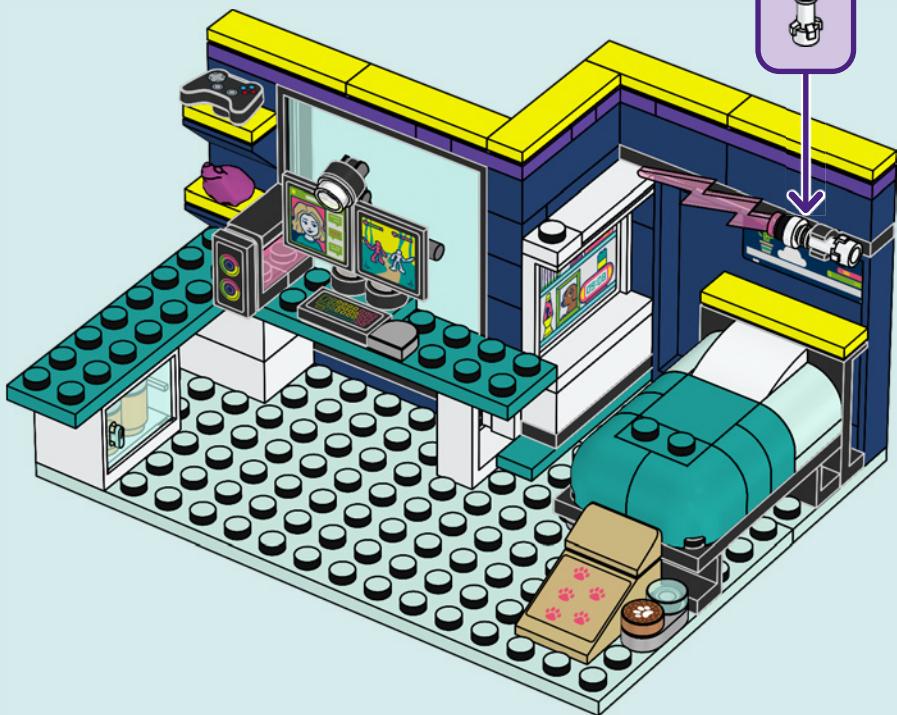
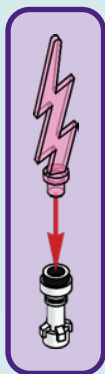





1x



1x



1x



1x

# 59

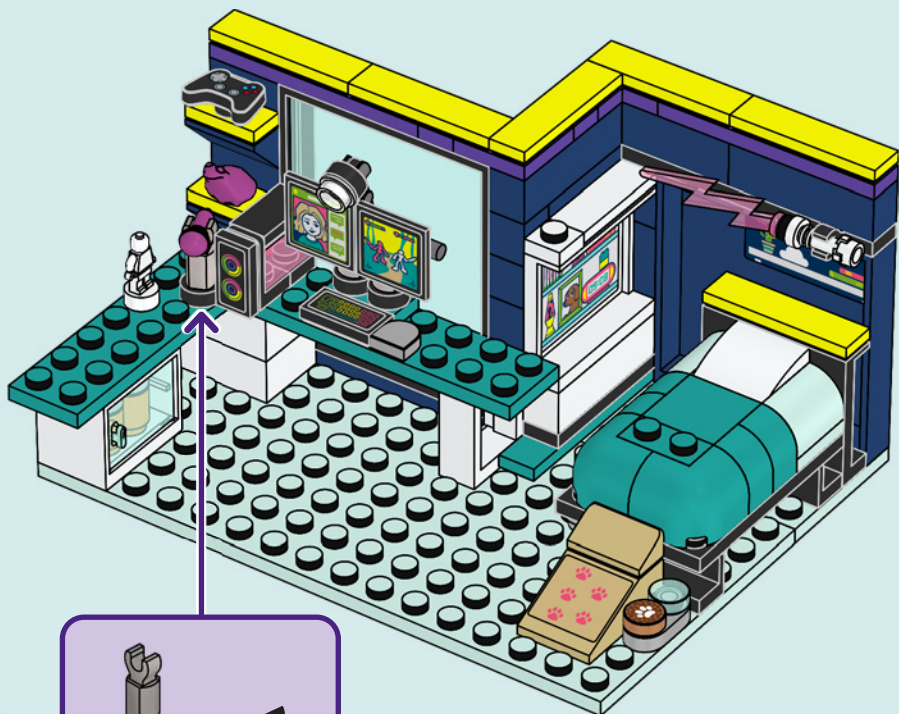

1



2





1x



1x



1x

# 60

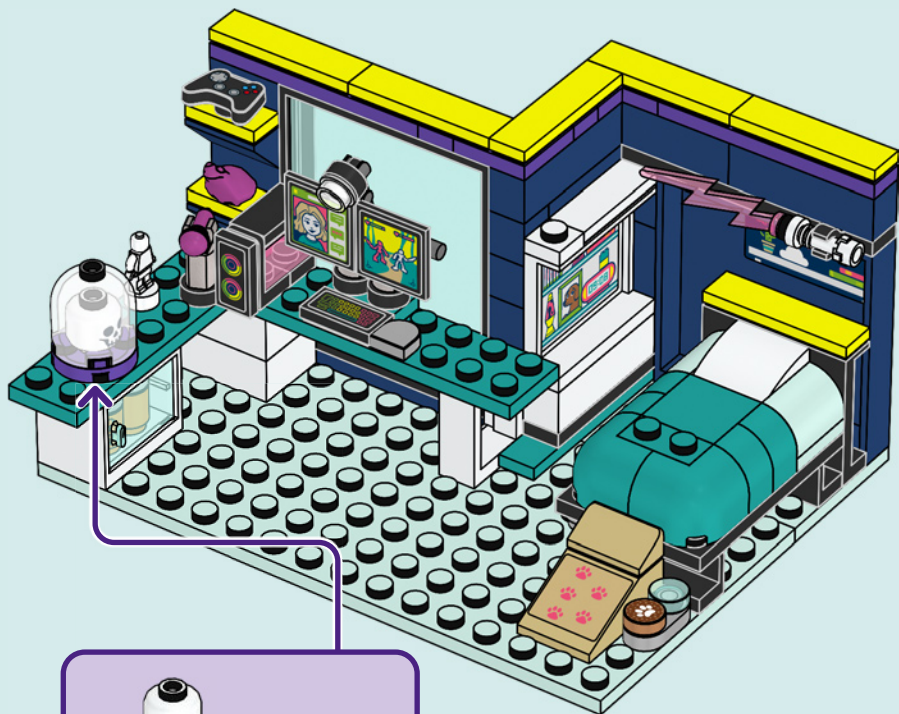

1



2







2x



2x



4x

# 61

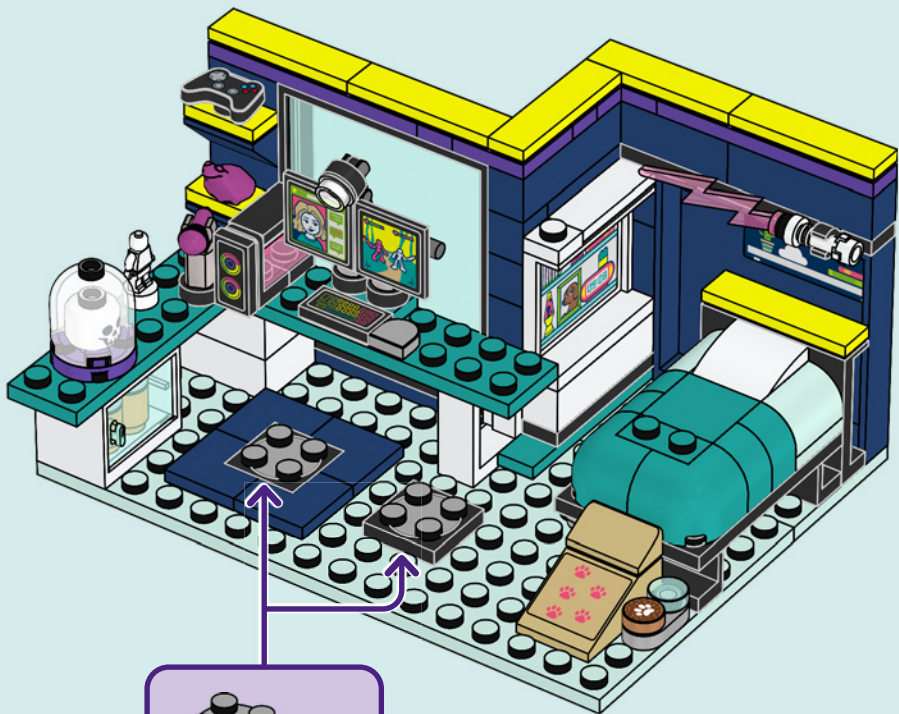

2x





1x



1x

# 62

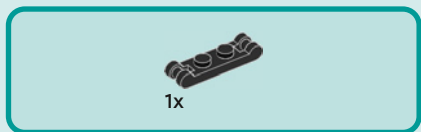
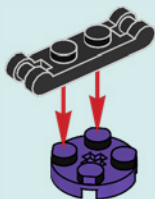

1x

# 63

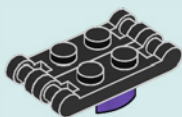



2x

64

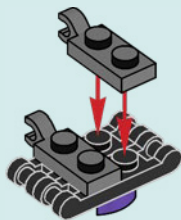

1x

65

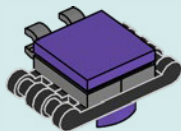



1x



2x

# 66

1



2



3

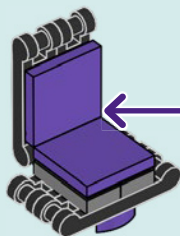
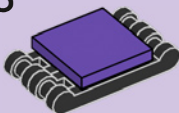



3x



3x

# 67

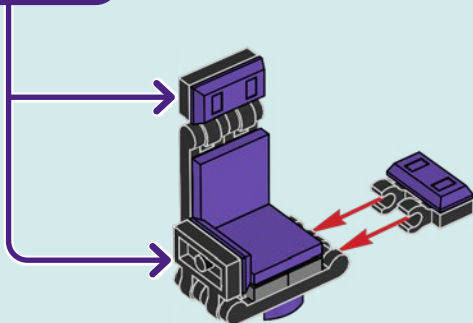
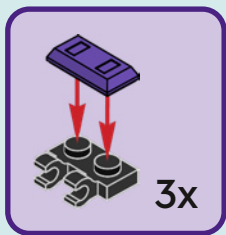

68

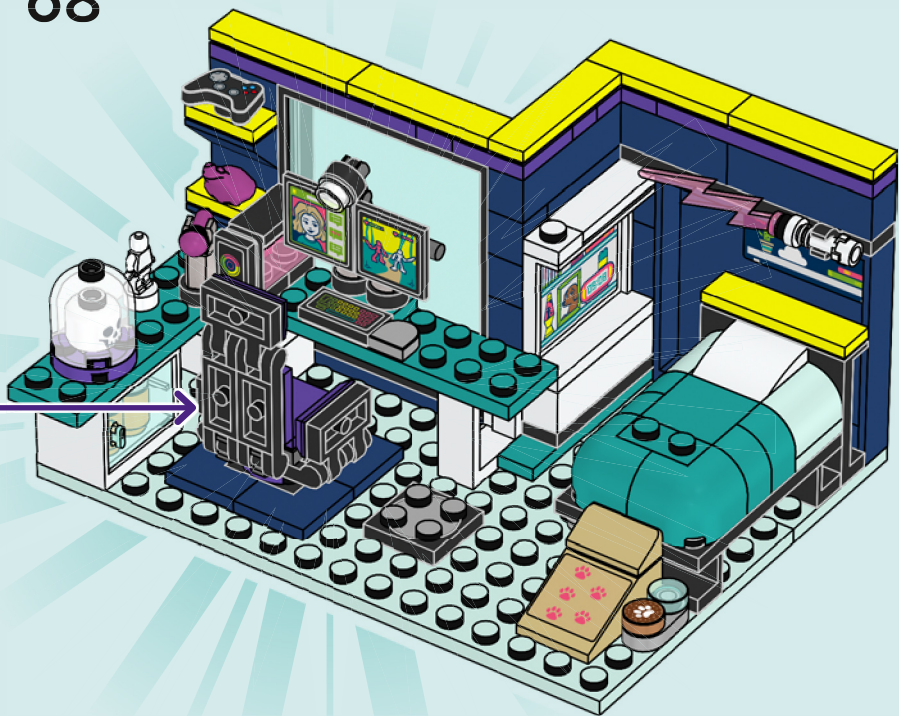



1x



1x



1x

69

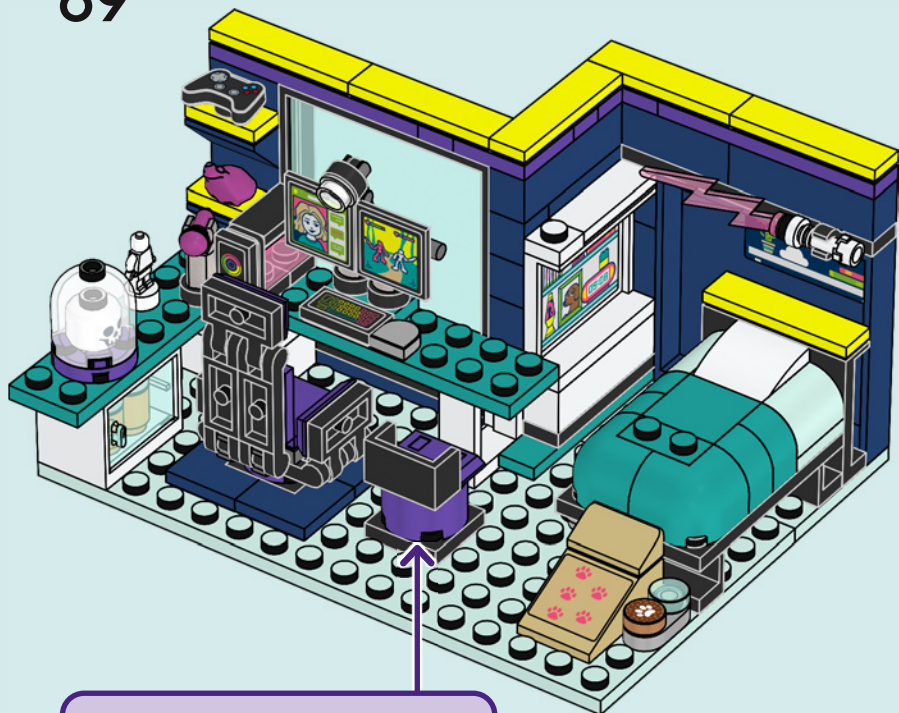

1

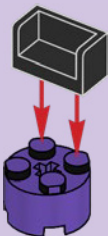

2

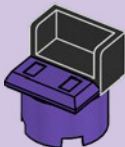







# Friends

41731



41728



41743



**LEGO**

**Friends**

**PAISLEY**

**AUTUMN**

**ALIYA**

**ZAC**





LEO

LIANN

OLLY

NOVA



  
1x  
6040333

  
1x  
6299492

  
1x  
4651445

  
2x  
302401

  
2x  
6320300

  
2x  
300401

  
1x  
6382045

  
1x  
6047220

  
2x  
300201

  
1x  
4619665

  
1x  
243101

  
1x  
4558208

90

  
1x  
301001

  
1x  
6284573

  
1x  
4624086

  
1x  
4218749

  
1x  
6409761

  
2x  
6092587

  
1x  
6020375

  
1x  
6146877

  
1x  
6294227

  
1x  
6416619

  
1x  
6429738

  
1x  
6429941

  
4x  
6186675

  
1x  
452226

  
1x  
302426

  
1x  
6335317

  
2x  
6323189

  
1x  
6275176

  
1x  
6409770

  
1x  
249626

  
3x  
306926

  
1x  
6313116

  
1x  
6248496

  
3x  
6310268

  
2x  
368026

  
2x  
6382491

  
4x  
6099483

  
1x  
4558209

  
1x  
6087083

  
3x  
6350415

  
1x  
6391342

  
1x  
303226

  
1x  
6416764

  
1x  
6240030

  
1x  
6286876

  
1x  
6274739

  
1x  
6253216

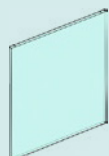
  
1x  
6254895

  
1x  
6244913

  
1x  
6294987

  
1x  
6421682

  
3x  
6213777

  
4x  
6399564

  
1x  
6273853

  
2x  
6393823

  
1x  
6338181

  
1x  
6264986

  
2x  
6257063

  
2x  
6220715

  
1x  
6257777

  
1x  
6395622

  
1x  
6416593

  
1x  
6430007

  
2x  
4255413

  
2x  
6345563

  
8x  
4249891

  
1x  
4667331

  
4x  
6103392

  
2x  
6025375

  
5x  
4264569

  
1x  
6399563

  
1x  
6250216

  
1x  
6097503

  
1x  
6428507

  
1x  
6429929

  
2x  
4211525

  
1x  
6250597

  
1x  
6248890

  
2x  
4540203

  
2x  
4211881

  
1x  
6186622

  
1x  
6344022

  
2x  
4211066

  
2x  
6336990

  
1x  
6378143

  
2x  
6231376

  
2x  
6030534

  
1x  
4622176

  
4x  
6394865

  
2x  
6167461

  
2x  
6057386

  
2x  
4655691

  
1x  
6287856

  
3x  
6339866

  
2x  
6322904

  
1x  
6167576

  
1x  
6215447

  
1x  
6363150

  
1x  
6258405

  
2x  
6389819

  
7x  
6389817

  
2x  
6236575

  
3x  
6138662

  
1x  
6421475

  
1x  
6295267

 [LEGO.com/service](https://www.LEGO.com/service)



YOU COULD

WIN



Scan this QR code or go to  
**LEGO.COM/PRODUCTFEEDBACK**  
and give us your short feedback  
about this LEGO® set for a chance  
to win a cool LEGO prize.

Terms and Conditions apply\*

**DE: Du könntest GEWINNEN.** Es gelten die Teilnahmebedingungen\* **FR: Tu pourrais GAGNER.** Des conditions s'appliquent\* **IT: Potresti VINCERE tu.** Termini e condizioni sono applicabili\* **ES: Puedes GANAR.** Aplican términos y condiciones\* **PT: Poderá GANHAR.** Aplicam-se termos e condições\* **JA: プレゼント付き! 利用規約が適用されます\*** **ZH: 轻松获奖. 条款和条件适用\*** **KO: 상품의 주인이 되어보세요. 소정의 약관이 적용됩니다\*** **RU: Вы можете ВЫИГРАТЬ.** Действуют положения и условия\* **PL: Szansa na WYGRANĄ.** Obowiązują warunki korzystania\* **CS: Máte šanci VYHRÁT.** Platí všeobecné smluvní podmínky\* **SK: Máte šancu VYHRÁT.** Platia všeobecné zmluvné podmienky\* **HU: TE IS NYERHETSZ.** Felhasználási feltételek érvényesek\* **RO: Ai putea CÂȘTIGA.** Se aplică termeni și condiții\* **BG: Можете да СПЕЧЕЛИТЕ.** Има определени правила и условия\* **LV: Tu vari LAIMĒT.** Ir spēkā noteikumi un nosacījumi.\* **ET: Sul on võimalus VÕITA.** Kehtivad tingimused\* **LT: Jūs galite LAIMĖTI.** Taikomos sąlygos\*

\*[LEGO.com/productfeedback-terms](https://www.lego.com/productfeedback-terms)

LEGO, the LEGO logo and the FRIENDS logo are trademarks of the/son des marques de commerce du/son marcas registradas de LEGO Group. ©2023 The LEGO Group. All rights reserved/Tous droits réservés/Todos los derechos reservados.