



CITY

60367





Get excited about our new packaging!

We're switching from plastic to paper-based packaging. That's why you might find a mix of paper and plastic in our boxes!

Nos nouveaux emballages vous emballeront !

Nous passons des emballages en plastique aux emballages à base de papier. C'est pourquoi vous pourriez trouver un mélange de papier et de plastique dans nos boîtes !

¡Te presentamos nuestros nuevos empaques!

Estamos sustituyendo las bolsas de plástico por bolsas con base de papel. ¡Por eso, puedes encontrar una mezcla de papel y de plástico en nuestras cajas!

[LEGO.com/sustainable-packaging](https://www.lego.com/sustainable-packaging)



BUILDER



Apple and the Apple logo are trademarks of Apple Inc., registered in the U.S. and other countries and regions. App Store is a service mark of Apple Inc. Google Play and the Google Play logo are trademarks of Google LLC. Tencent and the Tencent logo are trademarks of Tencent Inc.

Q [LEGO.com/devicecheck](https://www.lego.com/devicecheck)

EN Ask parents' permission before going online | **DE** Eltern um Erlaubnis bitten, bevor du online gehst | **FR** Demande l'autorisation d'un parent avant d'aller en ligne | **IT** Chiedi il permesso ai tuoi genitori prima di andare online | **ES** Pídeles permiso a tus papás antes de conectarte a Internet | **PT** Peça autorização aos pais antes de acederes online | **ZH** 上网前应先征得父母的同意 | **PL** Poproś rodziców o zgodę, zanim wejdiesz do Internetu | **CS** Než půjdeš na internet, požádej rodiče o svolení | **SK** Skôr než pôjdeš na internet, vypýtaj si povolenie od rodičov | **HU** Kérj szülői engedélyt, mielőtt online csatlakoznál! | **RO** Cere permisiunea părinților înainte de a te conecta online | **BG** Поискайте разрешение от родител, преди да влезете онлайн | **LV** Pirms došanās tiešsaistē palūdz atļauju vecākiem | **ET** Enne Interneti kasutamist küsi vanematelt luba | **LT** Prieš prisijungdami prie interneto, atsi klauskite tėvų

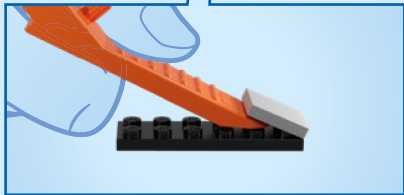
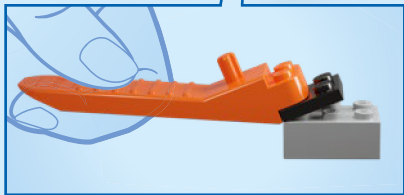
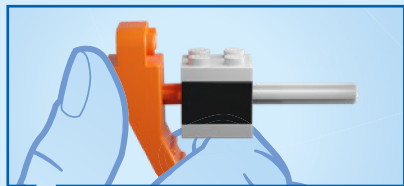
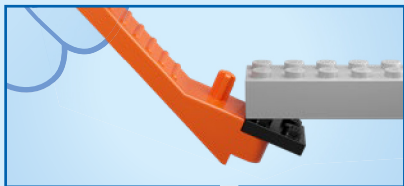

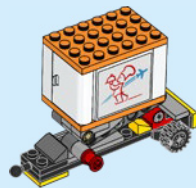
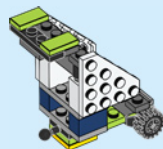
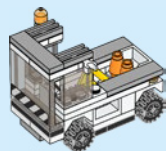
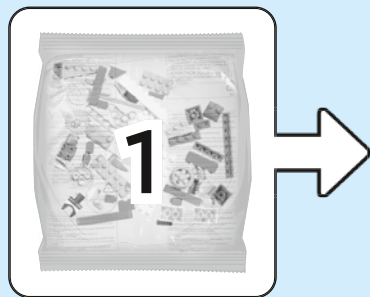

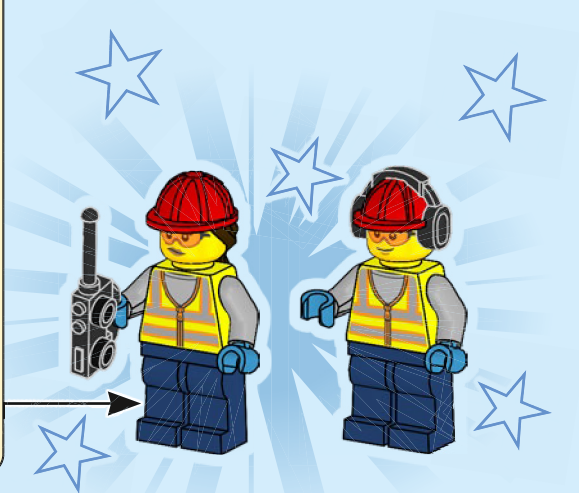
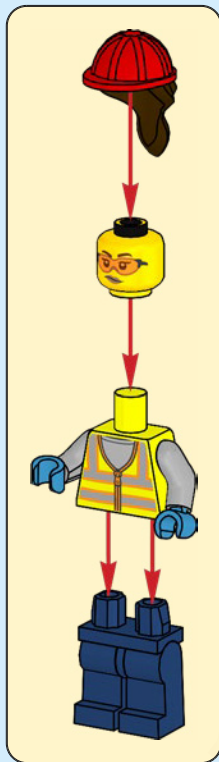

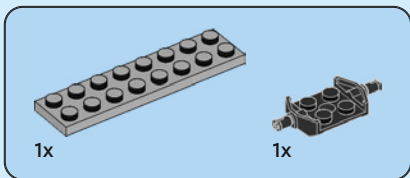
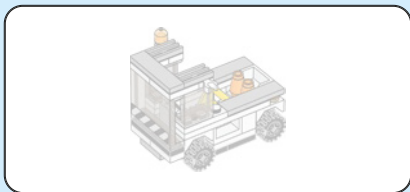

1

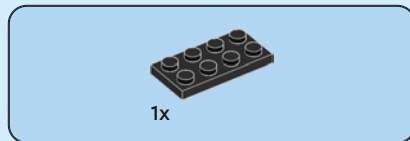
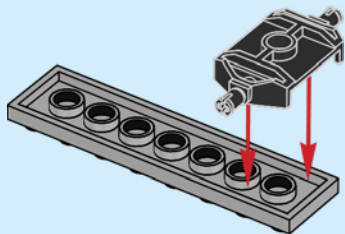

2

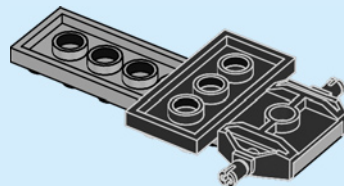



1x

3

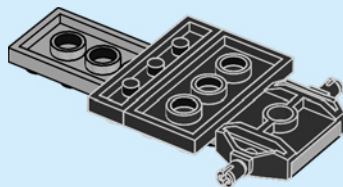

1x

4

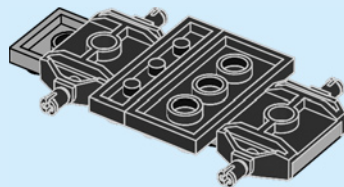

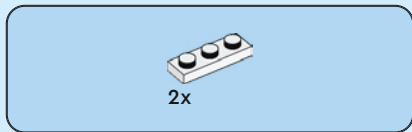

5

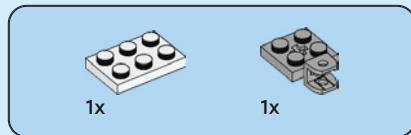
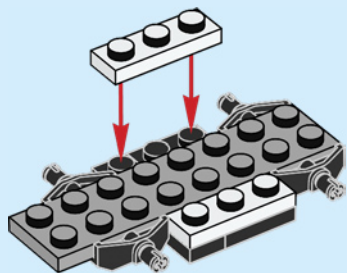

6

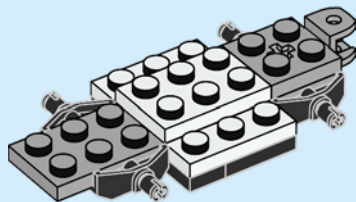

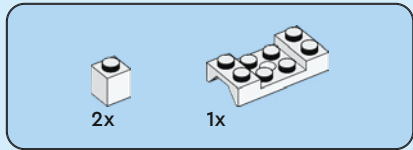

7

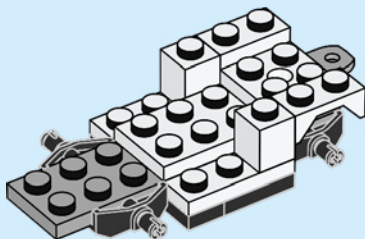



1x



1x

8

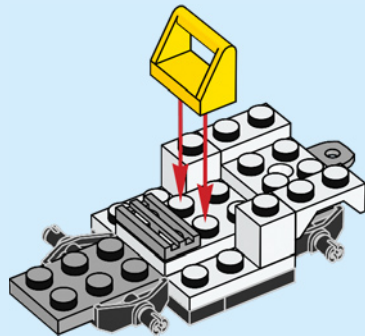

2x



1x

9

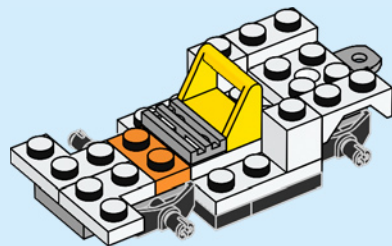



2x

10

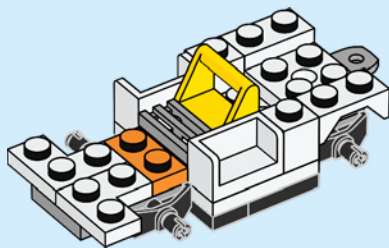

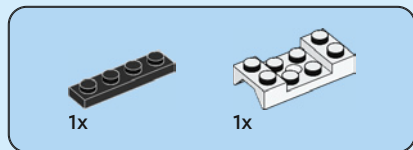

11

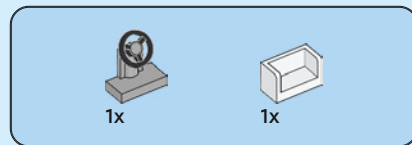
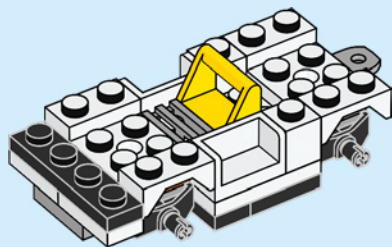

12

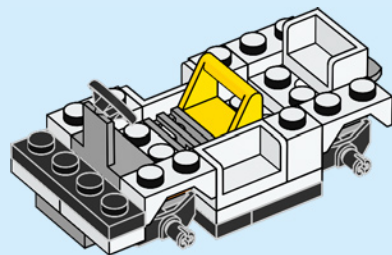

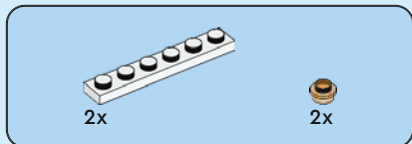

13

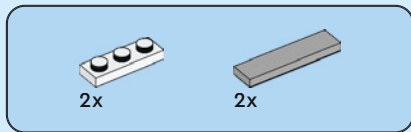
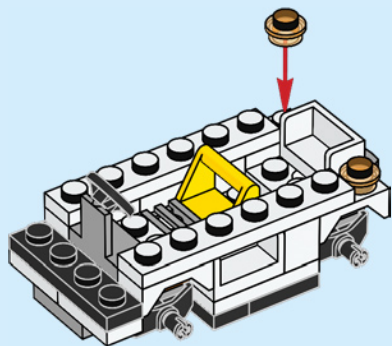

14

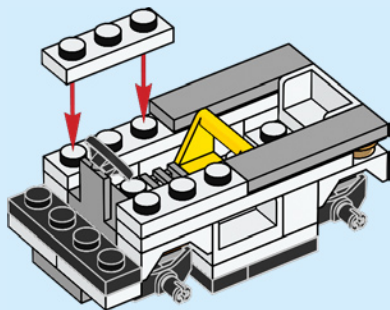

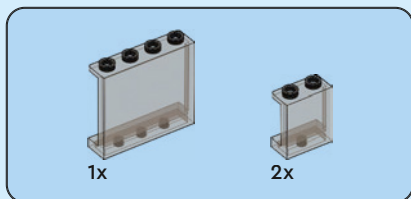

15

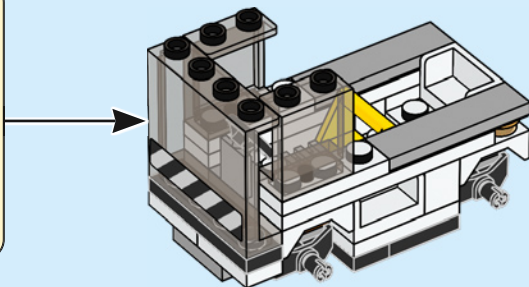
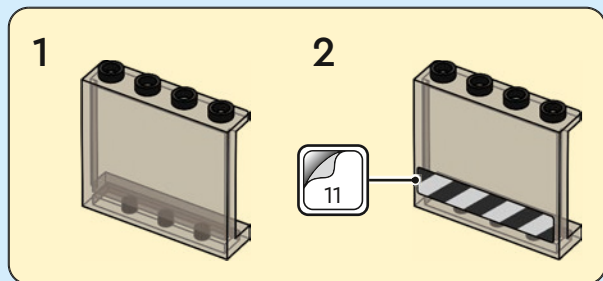



2x



2x

16

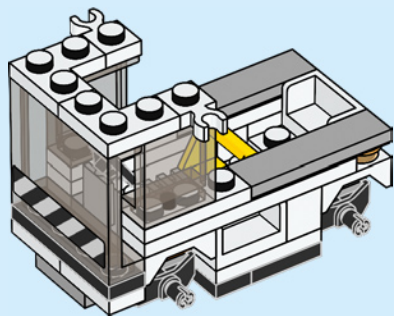

2x

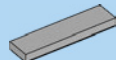

1x

17

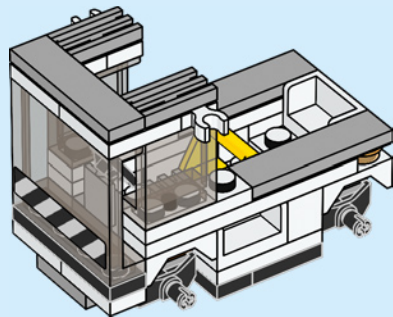



4x



4x

18

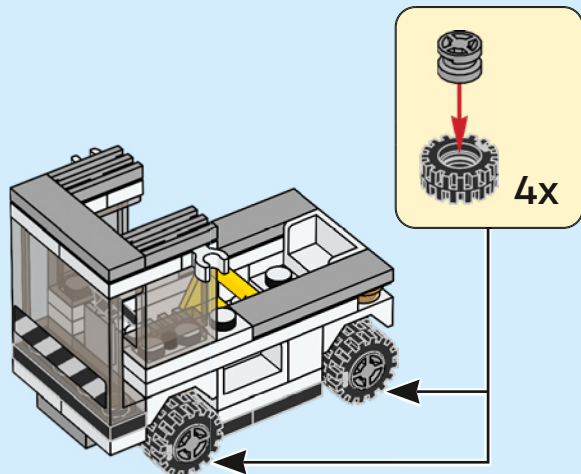

2x



1x

19

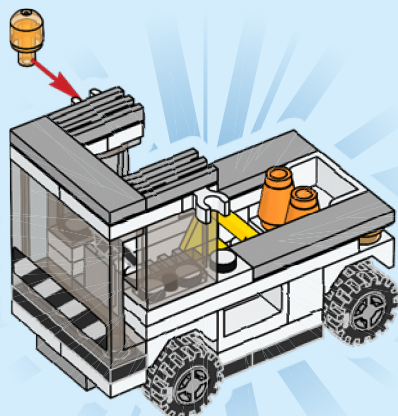

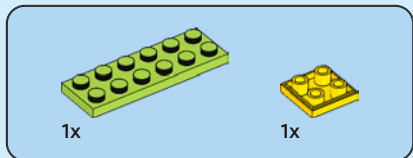

1

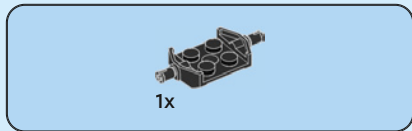
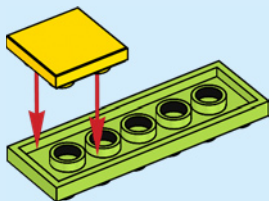

2

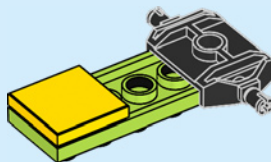

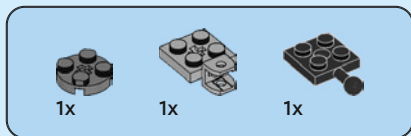

3

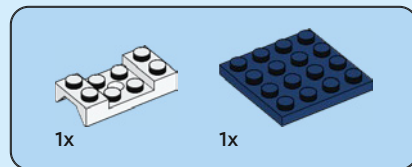
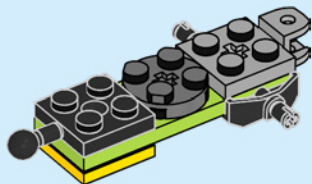

4

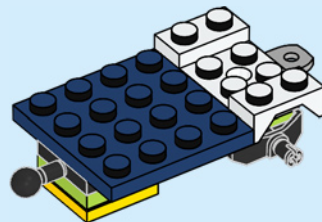

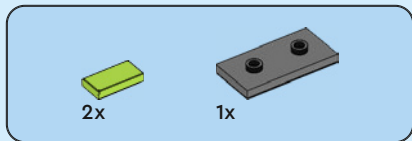

5

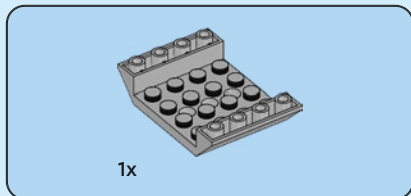
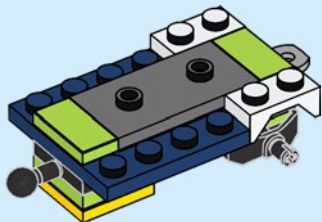

6

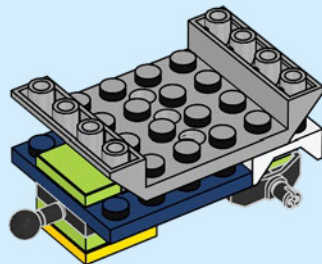

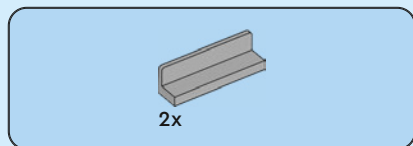

7

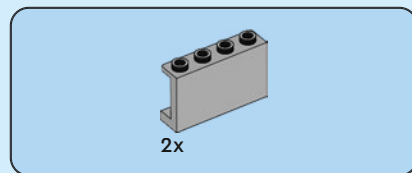
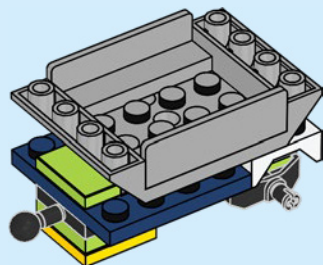

8

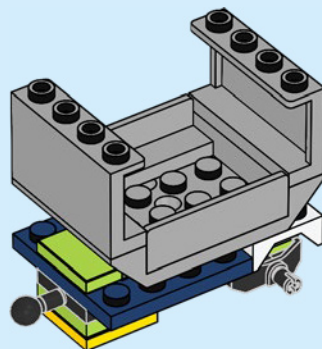



9

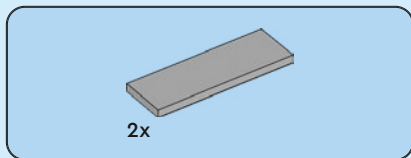
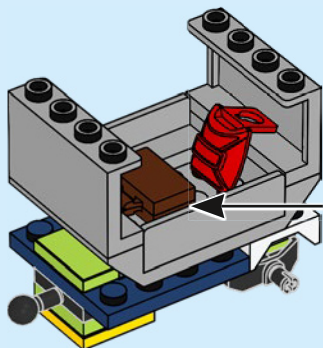
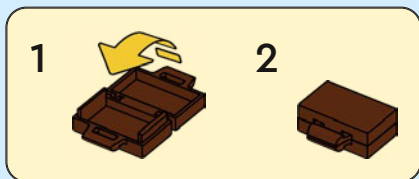

10

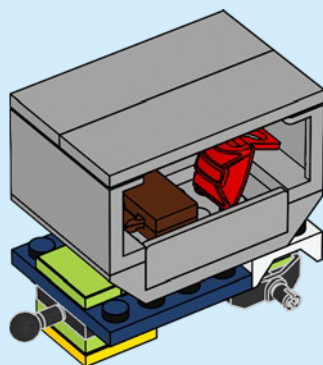



2x



2x

11

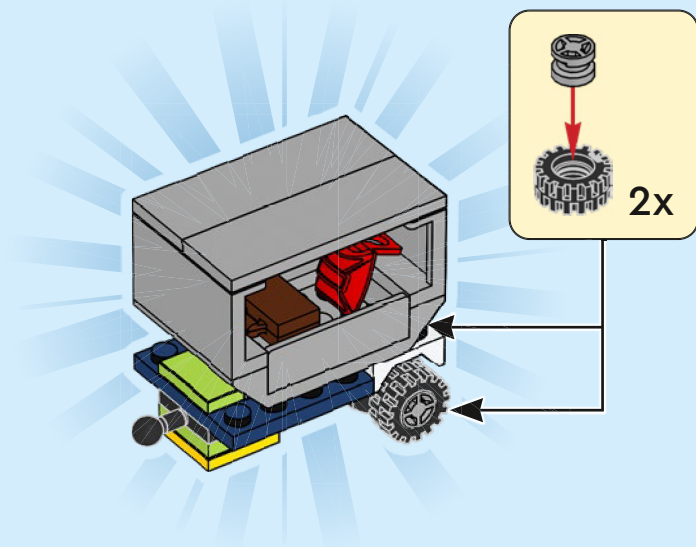

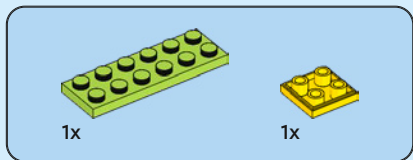
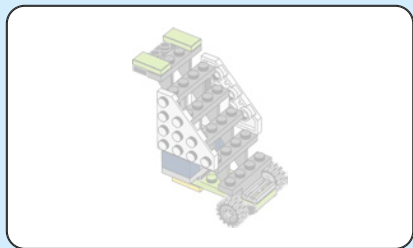

1

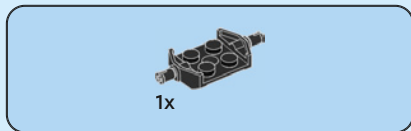
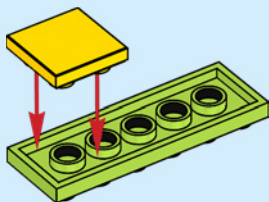

2

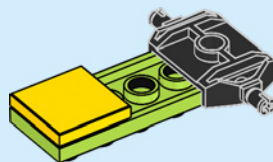



1x



1x

3

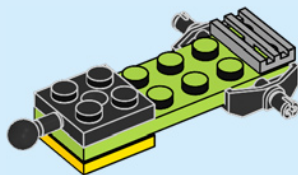

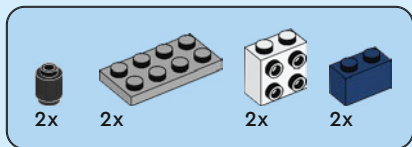

4

1

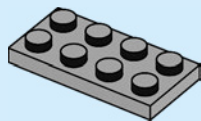

2

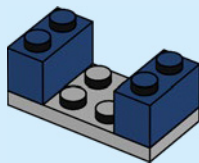

3

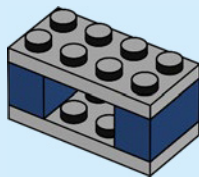

4

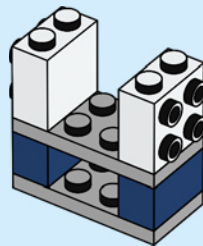

5

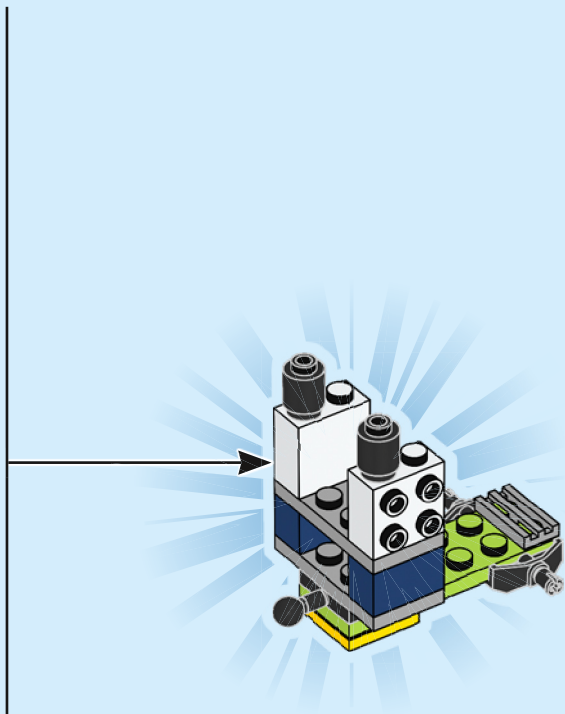
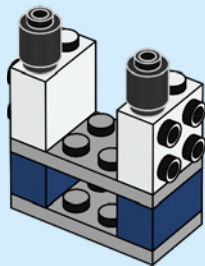

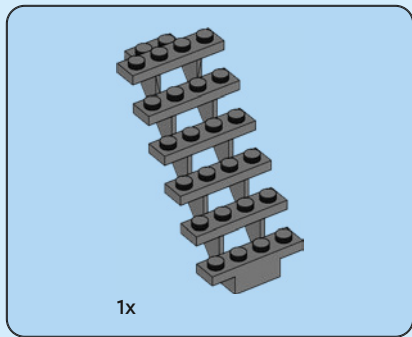

5

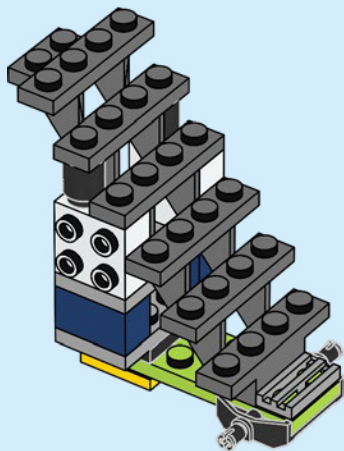



2x

6

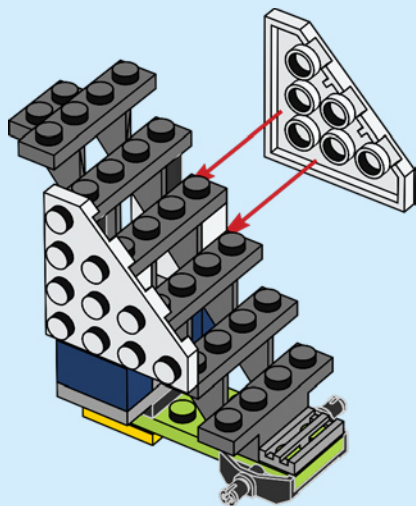



1x

7

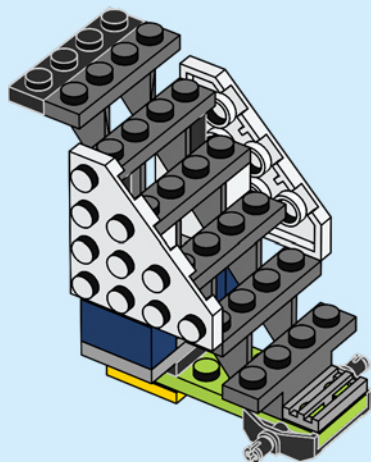

2x

8

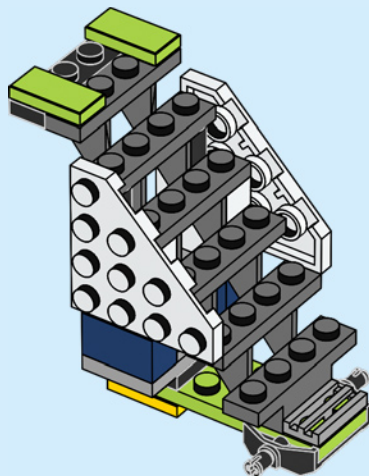



2x



2x

9

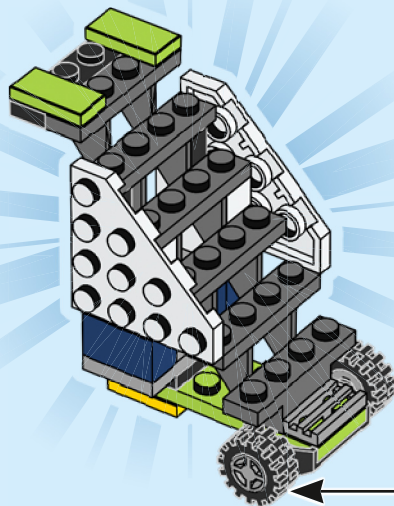

2x



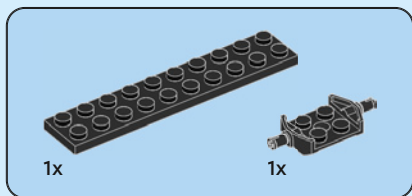
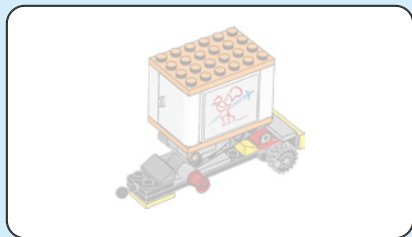

1

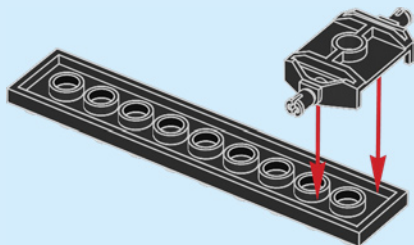



1x

2

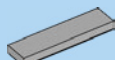
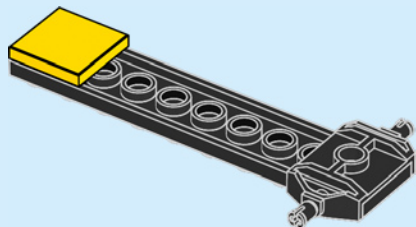

1x



1x



1x

3

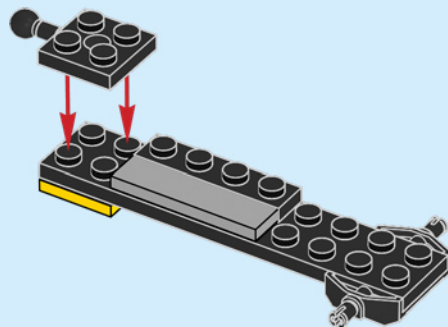

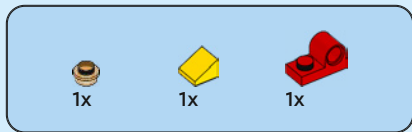

4

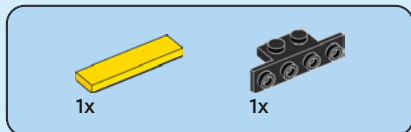
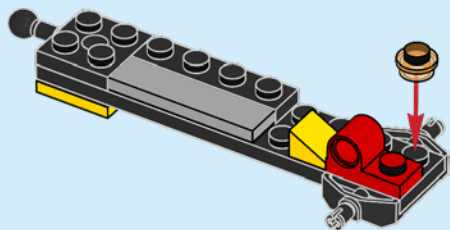

5

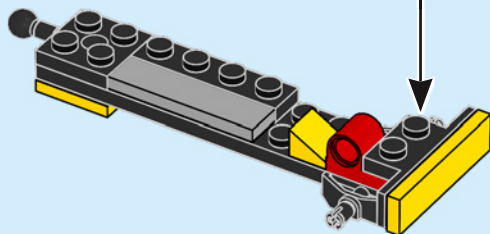
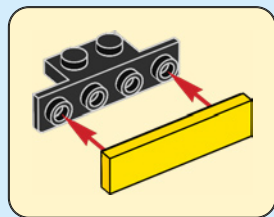

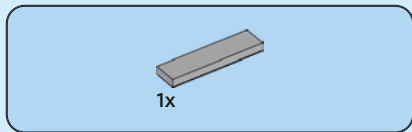

6

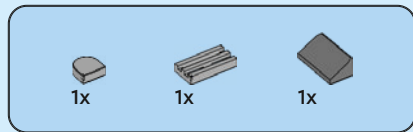
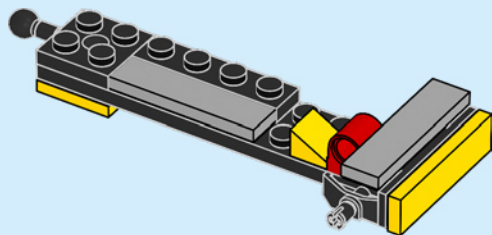

7

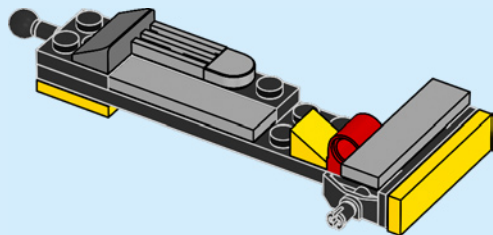

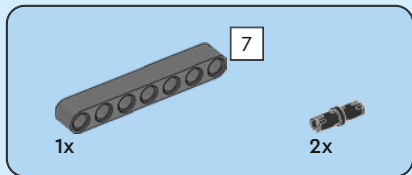

8

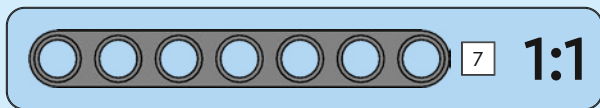
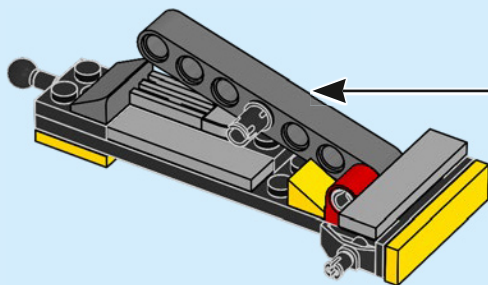
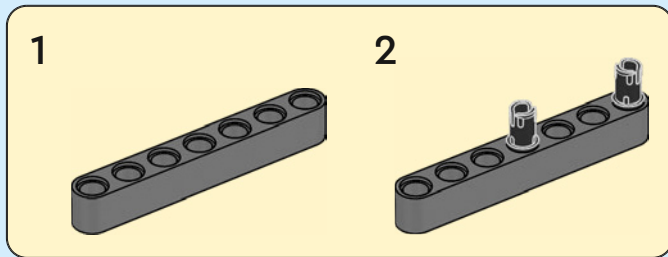

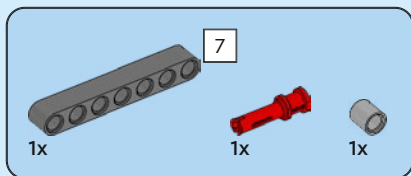

9

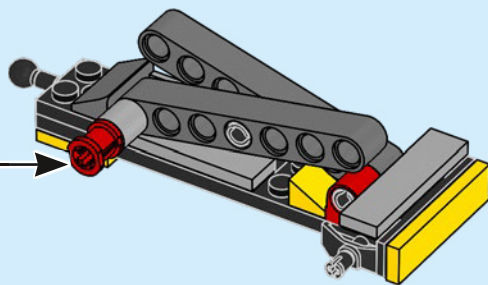
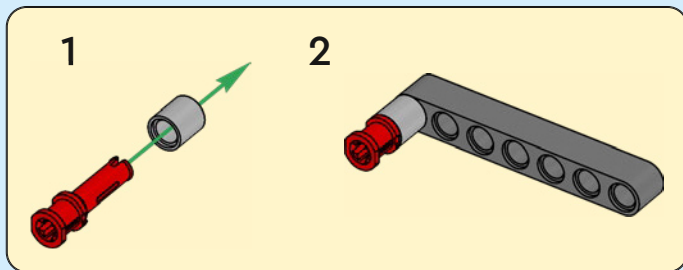

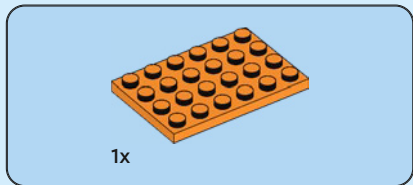

1x

10

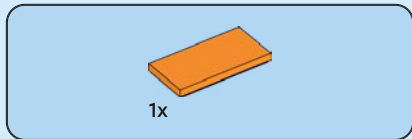
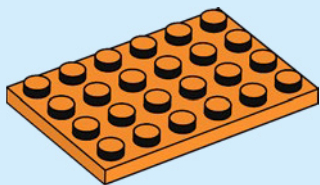

1x

11

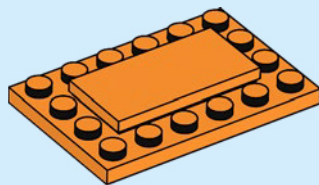

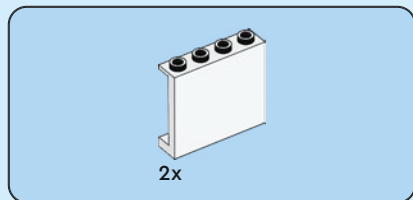

12

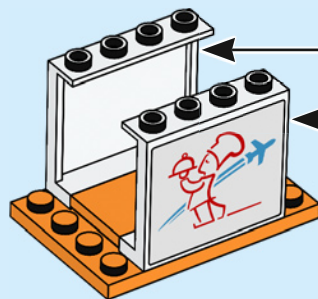
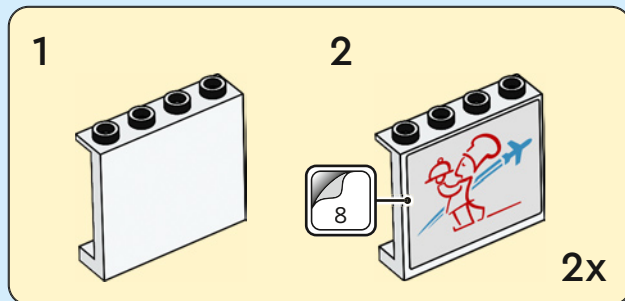



2x

13

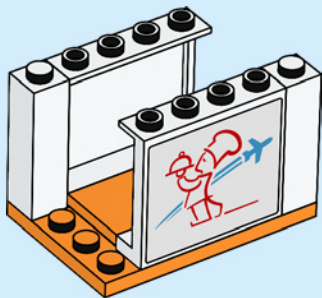

2x

14

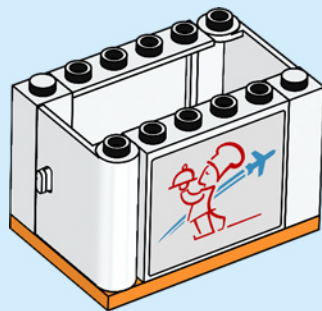

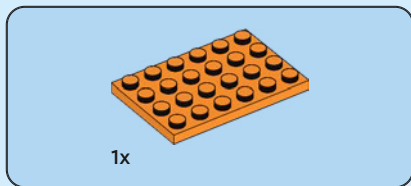

15

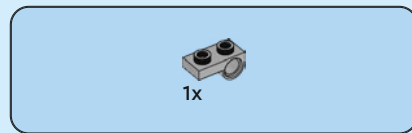
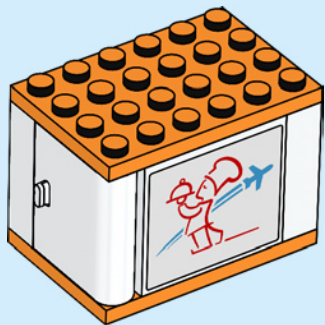

16

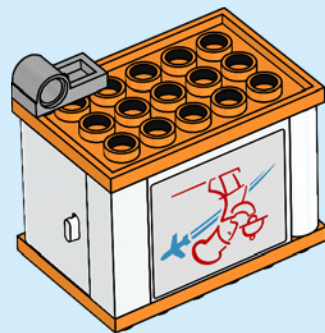



1x

17

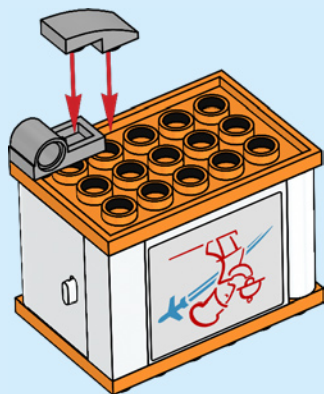

1x

18

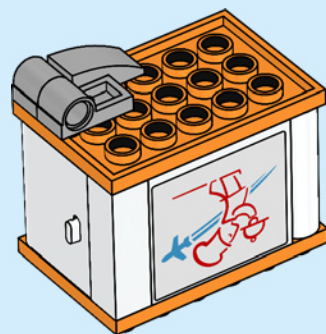



1x

19

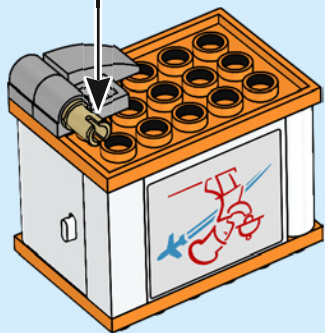
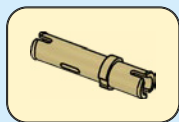

20

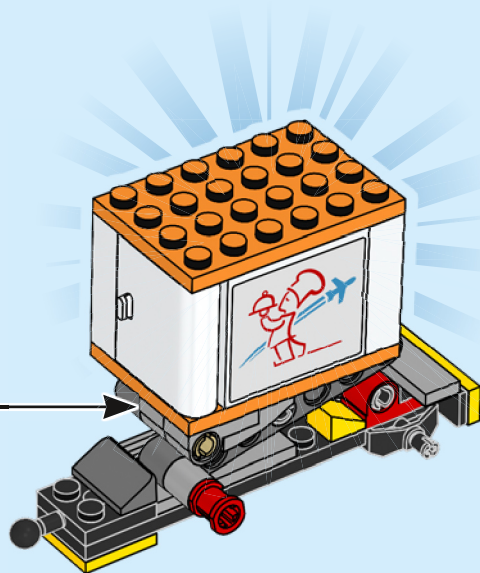



2x



2x

21

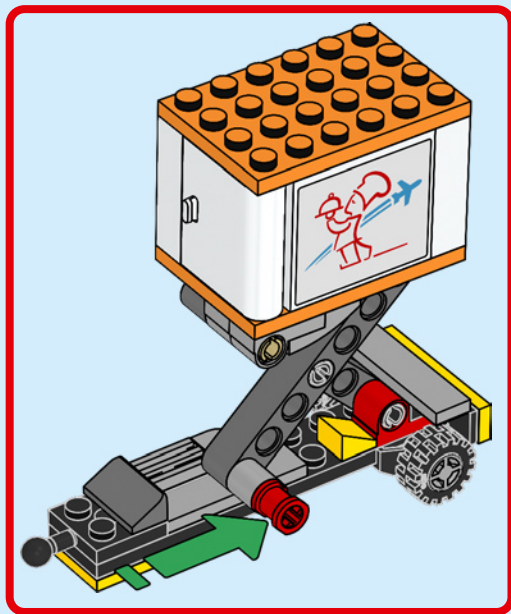
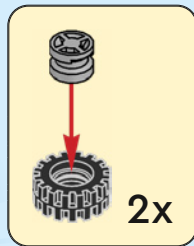
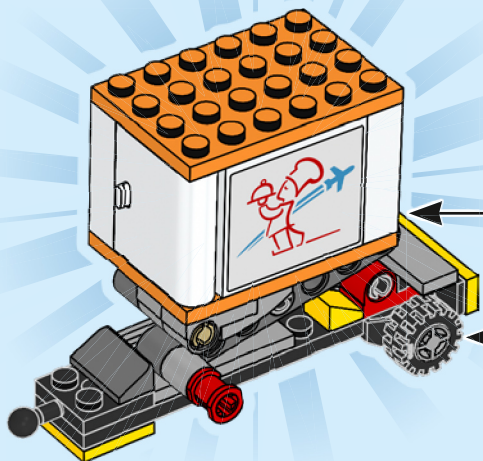

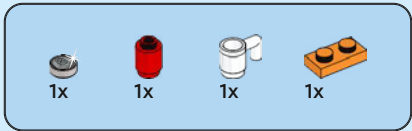

22

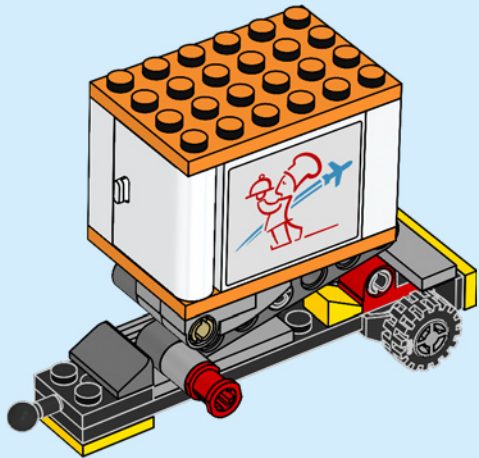
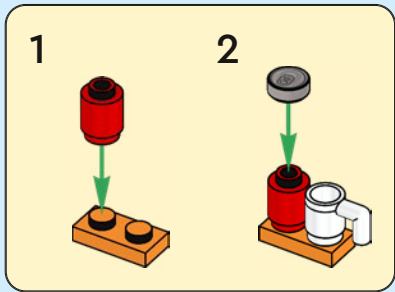

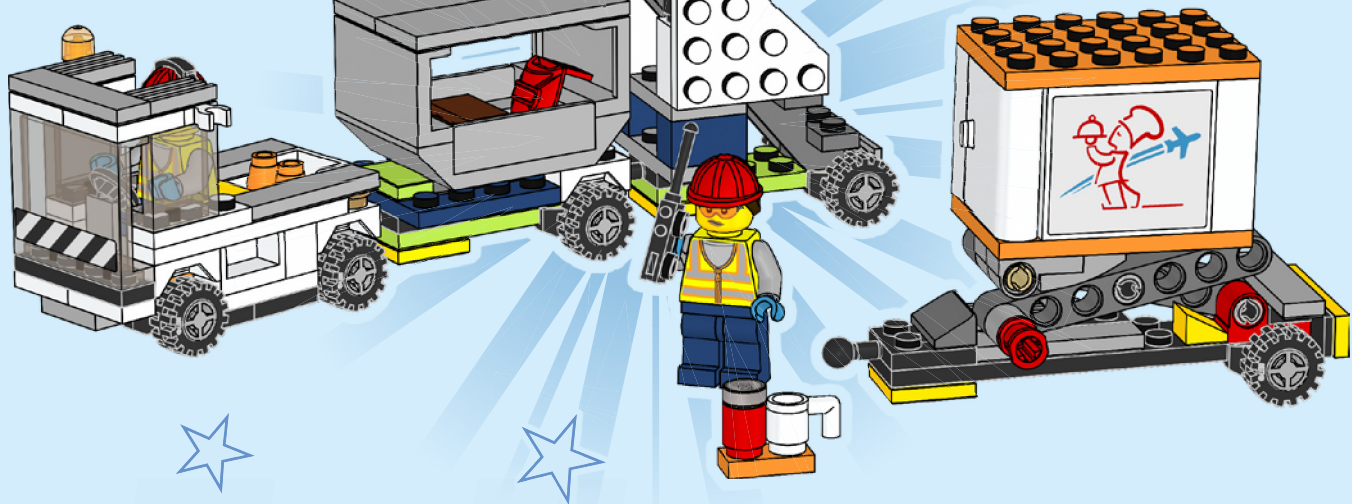



LEGO and the LEGO logo are trademarks of the/son des marques de commerce du/
son marcas registradas de LEGO Group. ©2023 The LEGO Group. 6478019